



Pool Vac Ultra®



Installation Manual



Rainbow Pool Products

PO Box 2388, Mansfield Qld 4122

Telephone STD 61-7-3849 5385

Facsimile STD 61-7-3849 5384

Email: info@rainbowpoolproducts.com.au

Web: www.rainbowpoolproducts.com.au



Pool Vac Ultra

INSTALLATION MANUAL

Congratulations on your purchase of the Pool Vac Ultra automatic pool cleaning system from Hayward. The Pool Vac Ultra is the smart, efficient way to clean your in-ground pool. The Pool Vac Ultra is powered by your pool's filter system and is designed to work well with most systems. Therefore the performance of the Pool Vac Ultra in your pool will be relative to that power source. Because the operation and performance of the Pool Vac Ultra are system reliant, there is a remote possibility that a "service call" may be necessary to complete the proper installation of your Pool Vac Ultra. Because this is an installation related call, it will be at the consumer's expense. Also, one or more of the accessories designed for the Pool Vac Ultra, including additional hose sections (if needed) might be applicable to your installation. Consult your Hayward Pool Vac Ultra dealer for price and availability. For Technical Assistance, call Hayward at 1-800-227-1477 (USA only).

For Your Records

Record the following information for your convenience.

- 1) Purchase Date _____
- 2) Serial Number _____

Note

The Pool Vac Ultra should not be used to clean the pool for spring start-up unless the conditions noted in Step 1 are met. On those occasions, where your pool is subjected to an abnormal debris load, maintenance steps should be taken to return the pool to "pre-installation" condition.



Pool Vac Ultra

OPTIONAL ACCESSORIES

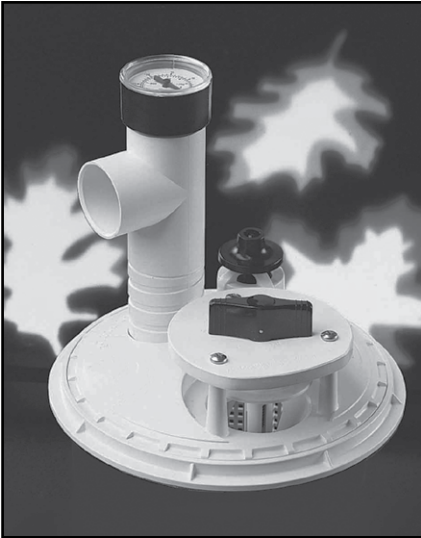

The **Hayward Skimmer Vac Plate** is a great accessory for achieving a pool cleaning balance that automatically alternates between skimming the pool's surface and vacuuming with each cycle of the filtration system's time clock.

Benefits include:

- Finger-tip dial control for superior skimmer action and proper vacuum settings.
- Back-mounted vacuum gauge conveniently located for simple and accurate vacuum measurements.
- Adjustable standpipe for various skimmer models.
- Factory-set pressure relief valve for added safety.

Ruggedly built, the **Hayward Leaf Canister** easily connects between two cleaner hose lengths, trapping leaves and debris before reaching your pool's filter system. Its see-through design lets you know when to empty.

Benefits include:

- Extra-large basket traps leaves and debris before they reach the filter system.
- Superior design ensures that water will always bypass debris and maintain proper water flow to your pump.
- Easy-open lid provides quick access to the basket.
- Lexan see-through construction lets you see when the basket needs cleaning.

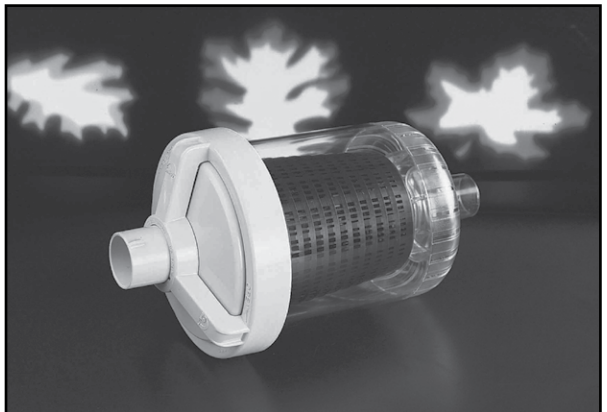

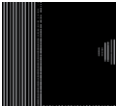

Installation

INSTALLING YOUR POOL VAC ULTRA IS SIMPLE...

To prepare your pool for Pool Vac Ultra installation, please follow the easy steps listed below. These instructions are also shown in the "Pool Vac Ultra Installation Video". After reading these instructions, the "How To" installation video will walk you through the installation step-by-step, and it will also give you some maintenance and troubleshooting hints. These instructions apply to all Pool Vac Ultra models.

Step 1

Check the pool and remove any large objects that might interfere with the cleaner's operation. **Check to see that the water level is at the recommended level.** Check the water chemistry. Make sure that the water is properly balanced and that the pool is free from algae. **Algae can adversely affect the operation of the Pool Vac Ultra, and its performance.**

Step 2

Clean or backwash the filter, and clean the hair and lint pot prior to installing the Pool Vac Ultra. Following the installation of Pool Vac Ultra, clean the system at regular intervals according to individual pool conditions.

Step 3

There are nine (9) connector hoses and one (1) leader hose with a hose cuff. The hose cuff has a red sticker attached to it that reads "**REMOVE LABEL AND CONNECT TO CLEANER**".

Connect the special Pool Vac Ultra hose sections together by pushing and twisting the tapered male connector end of each hose firmly into the open female end of the adjacent hose section (*see Figure 1*). Depending on the size and shape of your pool, all hose sections might not be used. However, the leader hose must be used or the Pool Vac Ultra will not operate properly. It is not necessary to "Bottom Out" the connections, but they **must** be tight enough to prevent any air leaks. Wetting the hose ends will make it easier to connect-the hose sections.

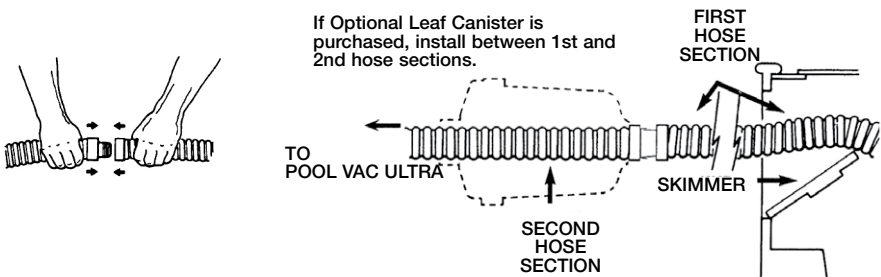
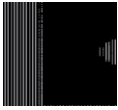

Figure 1





Installation

INSTALLING YOUR POOL VAC ULTRA IS SIMPLE...

Step 4

The hose should reach from the skimmer or dedicated vacuum line to the furthest point in the pool, **plus two (2) extra hose sections.** (The length of each hose section is four feet.) **This extra length is absolutely necessary for proper operation of the Pool Vac Ultra.** If the hose is not long enough, it will be necessary to purchase additional hose sections from your Hayward Pool Vac Ultra dealer. The hose length supplied (40 feet) has been determined to be sufficient for the majority of pools nationally. If your hose requirement is more than this, you must obtain additional hose sections for your cleaner to work properly. After the correct hose length has been assembled, fill hose completely with water. Insert Flow Gauge into the leader hose, then attach the C-Clip of the gauge onto the first hose section. Make sure the Flow Gauge is under water. (see Figure 2)

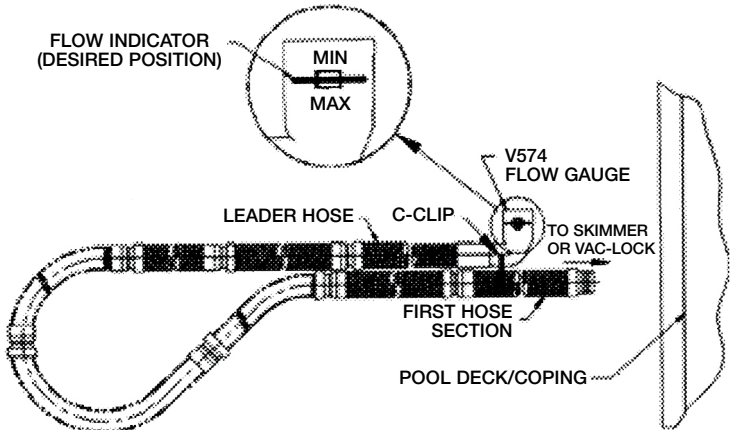

Figure 2

Step 5

Turn the filter system on and allow it to run long enough to eliminate any air in the system. Connect the V093C Skimmer Cone to the tapered male end of the vacuum hose if you are connecting the hose to your skimmer. Then, insert the cone into the suction port of the skimmer (see Figure 3) or, if you are using a Hayward Vac Lock, insert the hose end directly into the Vac Lock without using the cone. (Refer to **Important Tips** for more specific skimmer information.)

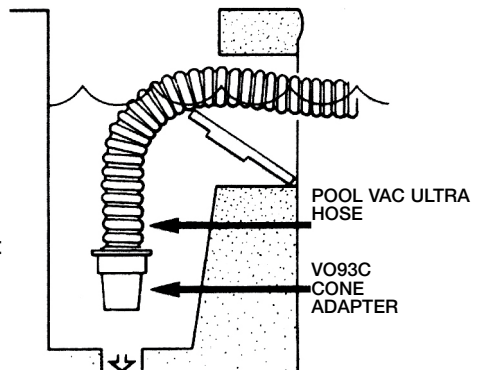
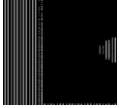

Figure 3



Installation

INSTALLING YOUR POOL VAC ULTRA IS SIMPLE...

Step 6

Check the water flow reading on the Flow Gauge. (Refer to Step 4, Figure 2). The black disk should be in the box between the "MIN" and "MAX" markings. If the setting is higher than required with the black disk outside of the box on the "MAX" side and you have connected your hose to the skimmer, it will be necessary to reduce the vacuum/water flow by using a valve or valves in the filter system, or the Hayward V094 Regulator Valve or an optional Hayward Automatic Skimmer Vacuum Plate designed to adjust vacuum/water flow. To install the V094 Regulator Valve, turn the filter system off. Remove the hose from the V093C Skimmer Cone, and after closing the Regulator Valve (Rotate the blue collar clockwise/toward + until closed/tight), insert the Regulator Valve into the Skimmer Cone, and insert the hose end into the Regulator Valve (see Figure 4).

Turn the filter system on and allow it to run long enough to eliminate any air in the system. Turn the blue collar counter clockwise until the proper reading appears on the gauge.

If a Hayward Skimmer Vacuum Plate is to be used, follow the installation instructions included with the Skimmer Vacuum Plate.

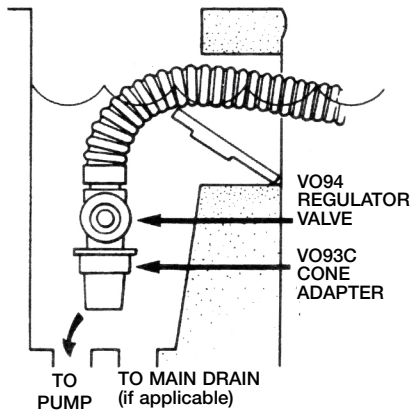

Figure 4





Installation

INSTALLING YOUR POOL VAC ULTRA IS SIMPLE...

Note

The V094 Regulator Valve and the Hayward Skimmer Vacuum Plate can only be used to LOWER an initial vacuum reading that is TOO HIGH. **The Regulator Valve and the Skimmer Vacuum Plate cannot be used to INCREASE the initial vacuum reading.** An initial reading that is too low to meet the water flow setting necessary to operate the cleaner is indicative of a system problem, and not a problem with the cleaner.

Contact your Hayward Pool Vac Ultra Dealer for assistance.

If you have connected your hose to a dedicated vacuum line it will be necessary to adjust the vacuum/ water flow using the 3-way valve at the filter system. The handle on the valve should be turned so that the Flow Gauge which is installed in the Pool Vac Ultra hose reads properly (refer to Figure 2).

Step 7

Remove the Flow Gauge from the hose and keep it handy. You will want to use the Flow Gauge to check the Pool Vac Ultra's operation from time to time.

Step 8

Check the rear flap adjuster dial at the left rear of the Pool Vac Ultra. It should be set at position number II which is the middle position (*see Figure 5*). Submerge the Pool Vac Ultra into the water and remove all of the entrapped air. When escaping air bubbles cease, you are ready to connect the hose.

Connect the hose cuff of the leader hose to the Pool Vac Ultra and submerge the hose to remove all air as when vacuuming the pool with a standard hand-vacuum (*see Figure 6*).

Do not use the return line/inlet water to “sink” the Pool Vac Ultra hose, as this will force air into the cleaner head, and possibly cause performance problems.





Installation

INSTALLING YOUR POOL VAC ULTRA IS SIMPLE...

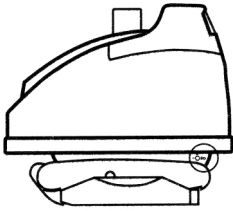

Figure 5

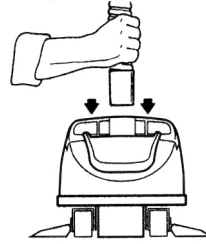
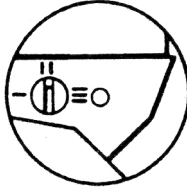

Figure 6

Step 9

Observe the Pool Vac Ultra in operation, and make sure that the return line flow is not affecting the Pool Vac Ultra's AquaPilot® programmed steering and preventing the Pool Vac Ultra from cleaning the entire pool. If the Pool Vac Ultra hose is being pushed across the surface of the pool, it will be necessary to redirect the return line water flow downward. This is to allow the Pool Vac Ultra to move in its programmed cleaning pattern.

Step 10

Observing the Pool Vac Ultra in operation, it should move about the pool without spending an excessive amount of time against the steps or other obstructions (vertical walls, ladders, etc). If the Pool Vac Ultra seems to get “hung up”, turn the rear flap adjuster to position I (see Figure 5).

Step 11

The Pool Vac Ultra will climb the vertical walls in swimming pools if there is at least a twelve inch (12") radius where the walls and floor meet. Pool Vac Ultra's wall climbing is governed by the programmed steering, and therefore it will not climb the wall each time it comes in contact with a wall. When the Pool Vac Ultra does start up a wall, it will not always go all the way up the wall. If the Pool Vac Ultra does not seem to be “sticking” to the wall, turn the rear flap adjuster to position III (see Figure 5).

If the Pool Vac Ultra climbs to the water's surface and sucks air, turn the rear flap adjuster to Position I (see Figure 5). If the cleaner continues to climb too high, reduce the water flow until proper operation is achieved.

Approximately eighty percent (80%) of the dirt in a concrete pool will be on the floor of the pool. Approximately twenty percent (20%) of the dirt will be on the walls. Your Pool Vac Ultra will spend its cleaning time accordingly.



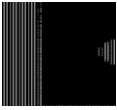

Pool Vac Ultra

IMPORTANT TIPS

In one piece fiberglass pools there is very little dirt on the walls, but the Pool Vac Ultra will still climb the walls. Due to the shape (severe angles) of most in-ground vinyl liner pools, the Pool Vac Ultra's cleaning is mostly confined to the bottom (both shallow and deep) and the hopper sides. However, normal dirt and debris do not adhere to these walls.

DO NOT COIL HOSE

When storing your cleaner the hose sections must be stored straight, not coiled. A coiled hose will create a memory in the hose that will impede the Pool Vac Ultra's ability to move properly in your pool. **Coiled hoses are not covered under the Hayward warranty.** When removing the Pool Vac Ultra from your pool, be sure to grasp the cleaner by its handle, not by its hose, otherwise your Pool Vac Ultra might be damaged should the hose disconnect from the cleaner.

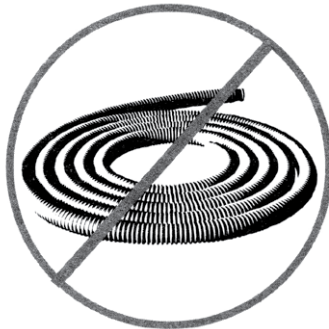

1. Skimmers come in many configurations and cannot all be described here. Three basic types are discussed however.

Some skimmers have two (2) holes in the bottom. There might be a valve, float or cover over the holes. Remove everything in the skimmer, exposing the holes. The rear hole is usually the suction port. In some cases it will be necessary to use the V094 Regulator Valve to control water flow through the Pool Vac Ultra (*see Figure 4*).

Some skimmers have only one hole in the bottom. This suction port is usually controlled by a valve at the filter system and most likely will not need a V094 Regulator Valve (*see Figure 3*).

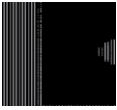

Pool Vac Ultra

IMPORTANT TIPS

Some skimmers have a vari-flow or diverter valve in the bottom of the skimmer. This valve can be turned to regulate skimming and main drain suction. Turn the valve to full skim and then adjust the Flow Gauge vacuum gauge by turning the valve toward main drain suction. Usually this valve is the same size as the Pool Vac Ultra hose end, and it will therefore be necessary to purchase a V098 Hose Adapter (*see Figure 7*).

After the proper gauge reading has been established, the diverter valve will have to be locked in place with a wedge of some kind so that it won't change position with operation of the Pool Vac Ultra.

2. Periodically check the water flow/vacuum to be sure that the Pool Vac Ultra is operating as efficiently as possible. Remember, too much vacuum is just as bad as too little.
3. Periodically check to make sure that the Pool Vac Ultra hose is securely attached to its suction source (i.e. Skimmer, Skimmer Vac Plate, Vac Lock, etc.)
4. Disconnect the Pool Vac Ultra hose from the skimmer/regulator valve, or, if using a "dedicated line", turn cleaner valve off prior to "backwashing", so as not to restrict water flow.
5. Never coil the Pool Vac Ultra hose. **Coiled hose is not covered under the warranty.**
6. When the Pool Vac Ultra is out of the pool, always disconnect the leader hose from the Navigator head.
7. Always carry Pool Vac Ultra by the molded-in handle. **Do not carry it by the hose.**
8. When swimming in the pool, remove Pool Vac Ultra from the water.
9. If you are going to super chlorinate, shock, or add gas chlorine to your pool, make sure the cleaner and its hose are removed prior to doing so.

Figure 7

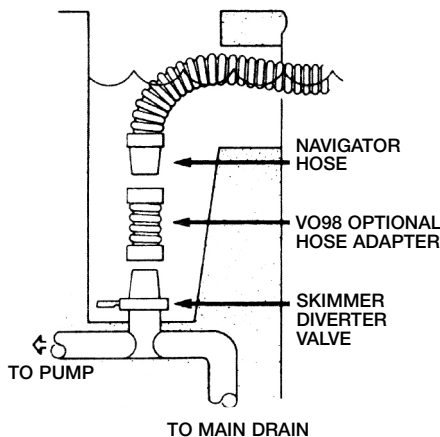

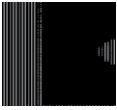

Pool Vac Ultra

MAINTENANCE TIPS

1. CHECK THE CONDITION OF THE “SHOES, WINGS AND FLAPS” PERIODICALLY.

The shoes and wings have wear indicators on their sides and should be checked occasionally to determine if they need replacing. The shoe wear indicator is a line on the side of the shoe that appears as a difference in texture. When this texture difference is no longer visible at the bottom of the shoe when viewed from either side, the shoes must be changed (*see Figure 8*). Also on the side, the wing wear indicator is a horizontal line which has three (3) vertical lines above it. When you can no longer see the horizontal line, the wings must be changed (*see Figure 9*). The Hayward **Pool Vac Ultra Tune-Up Kit** is available from your dealer. Shoes, wings and flaps may also be purchased separately.

2. SHOE REPLACEMENT:

- a) Turn unit upside down.
- b) Insert screwdriver between foot and shoe on one of the pods (*see Figure 8*).
- c) Using a lifting motion, remove the shoe from the foot.
- d) Dip a new shoe in water and attach the shoe to the foot, making sure to put the small post into the small hole and the large post into the large hole. These posts and holes are different sizes to prevent the shoes from being improperly installed.
- e) Repeat Steps b, c and d for each shoe.

Figure 8

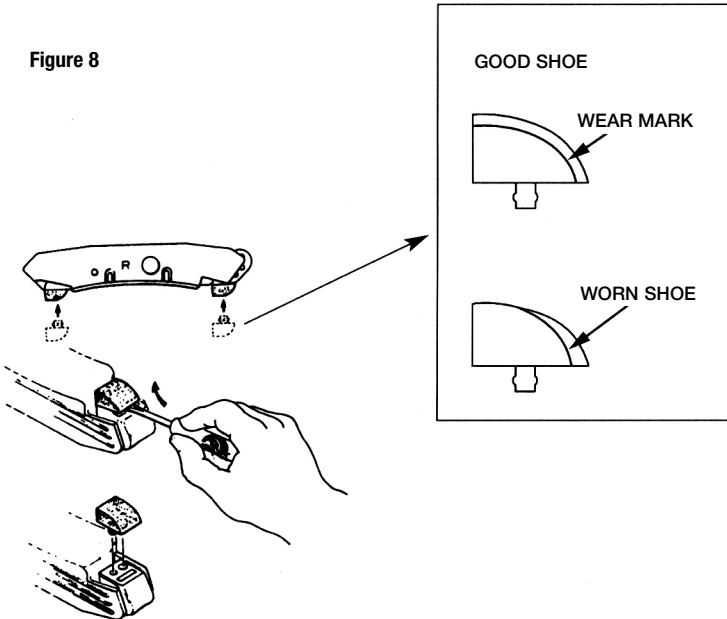

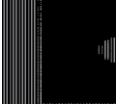

Pool Vac Ultra

MAINTENANCE TIPS

3. WING REPLACEMENT

- Using a screwdriver, remove the plugs from both pods (see *Figure 9*).
- Remove the old wings by bending the wings up toward the sides of the cleaner, and lift them off their hooks (see *Figure 10*). If any of the wing hooks are broken, take the Pool Vac Ultra to your dealer for pod replacement as the unit will not function properly if the wings are not properly attached.
- Replace the wings, making sure that you match the "L" (Left) and "R" (Right) of the pods.
- Replace the pod plugs and tap them into place

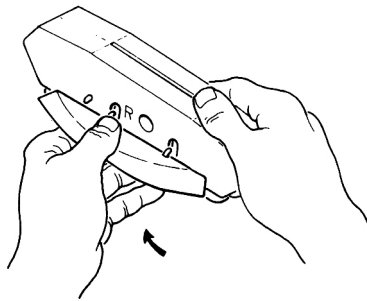
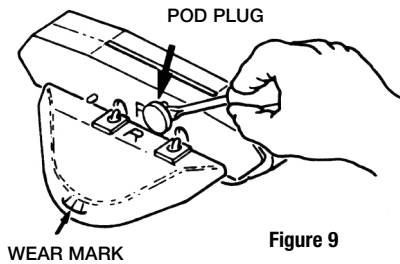

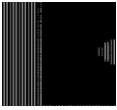

Pool Vac Ultra

MAINTENANCE TIPS

4. FLAP REPLACEMENT:

a) Remove the front and rear flaps from your Pool Vac Ultra by inserting a small screwdriver between the flap and the lower body near the pivot point of the flaps (see Figure 11).

BOTTOM OF CLEANER

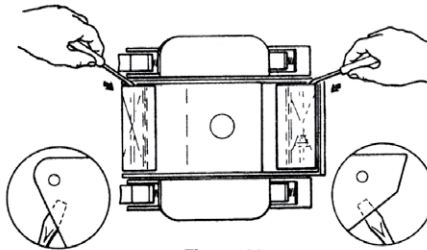

Figure 11

b) You will notice that your replacement flaps look similar but are marked "Front" and "Rear" on the flap.

Because the springs in the flaps are different, it is absolutely necessary to install the proper flap in the front and rear of the unit. Failure to do so will result in unsatisfactory performance of the Pool Vac Ultra. When installing the front flap, be sure that the extended leg of the spring is inserted into the notch at the front of the lower body (see Figure 12). Push the flap in place. You will actually feel and hear a snap when the flap is in place. Fold the flap in towards the bottom of the Pool Vac Ultra. You will feel some resistance at this point (that is normal). As the flap snaps into its normal position, you will feel the spring action and notice that the front flap is now in its normal operating position.

When installing the rear flap, the extended leg of the spring must fit against one of the flat surfaces of the cam (see Figure 12).

BOTTOM OF CLEANER

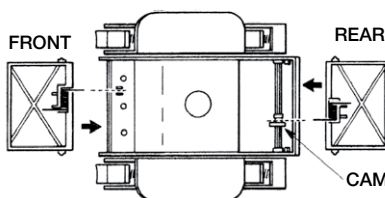
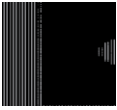

Figure 12



Pool Vac Ultra

MAINTENANCE TIPS

5. POOL VAC ULTRA BUMPER REPLACEMENT:

Replacement of the Pool Vac Ultra Bumper is not recommended as a "Do It Yourself" repair, because there is a slight possibility that the replacement might cause a problem in the propulsion system. We strongly suggest that you consult your Hayward Pool Vac Ultra dealer for this repair.

A #2 Phillips screwdriver is necessary for this repair.

- a) Turn off pump.
- b) Remove Pool Vac Ultra from pool.
- c) Disconnect Pool Vac Ultra from leader hose.
- d) Turn Pool Vac Ultra upside down, and place it in a position that is steady/firm.
- e) Locate and loosen the captive screw behind the throat in the center of the bottom (see Figures 13, 14 & 15).

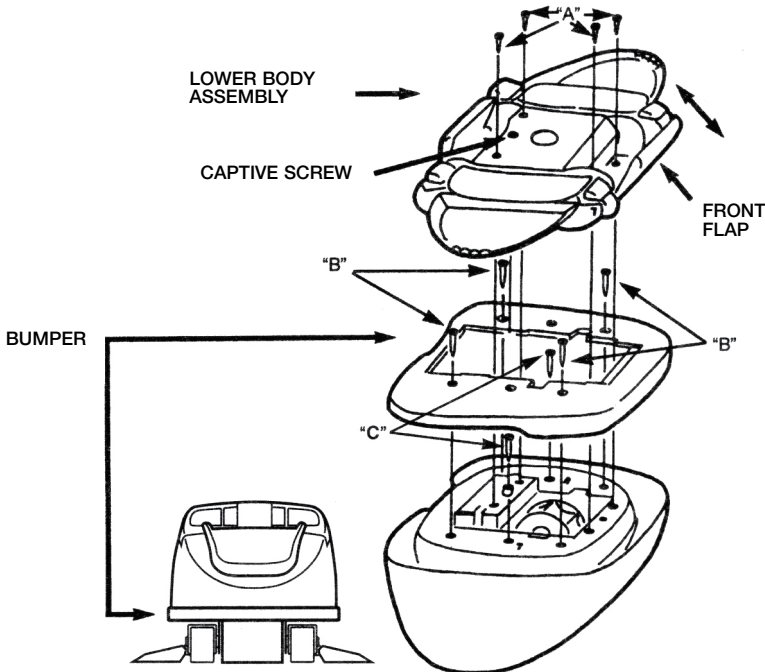
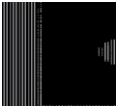

Figure 13



Pool Vac Ultra

MAINTENANCE TIPS

- f) Lift “Easy Opening Bottom” (see Figures 14 & 15).
- g) Remove four (4) “A” screws (see Figure 13).
- h) Lift the Lower Body Assembly off the Pool Vac Ultra (see Figure 13).
- i) Remove four (4) “B” screws (see Figure 13).
- j) Remove bumper carefully, making sure that other cleaner parts are not moved or disturbed.
- k) Remove two (2) “C” screws (see Figure 13).
- l) Replace bumper, again making sure that other cleaner parts are not moved or disturbed.
- m) Reinstall screws and parts, following steps in reverse - k, i, h, g, f, e, d, c.
- n) Reinstall Pool Vac Ultra in pool per installation instructions and/or installation video.

Figure 14 - Pool Vac Ultra Concrete

CAPTIVE SCREW

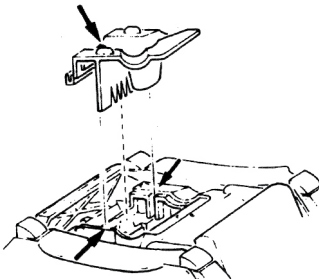

BOTTOM OF CLEANER

Figure 15 - Pool Vac Ultra Vinyl

CAPTIVE SCREW

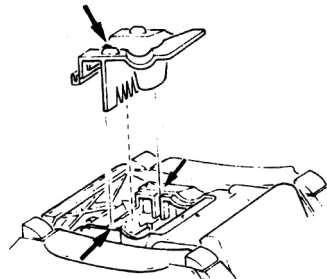

BOTTOM OF CLEANER



Removal Instructions

“EASY OPENING BOTTOM”

6. “EASY OPENING BOTTOM”.

The purpose of the “EASY OPENING BOTTOM” is to allow quick access to the turbine/vacuum chamber for easy cleaning and maintenance.

Should the Pool Vac Ultra stop moving or become sluggish due to debris trapped in the throat or inside the unit, the turbine/vacuum chamber is accessible following the instructions on pages 12 and 13 of this manual.

1. Turn off pump.
2. Remove Pool Vac Ultra from pool.
3. Disconnect Pool Vac Ultra from leader hose.
4. Turn Pool Vac Ultra upside down.
5. Locate and loosen the captive screw behind the throat in the center of the bottom (*see Figures 14 and 15*).
6. Lift “Easy Opening Bottom” (*see Figures 14 and 15*).
7. Clean turbine/vacuum chamber (*see Figure 16*).
8. Check turbine for free movement.
9. Reinstall “Easy Opening Bottom” by lining up the cover screen with the two slots shown in Figures 14 and 15. Then slide the cover in place and tighten the captive screw.
10. Reinstall Pool Vac Ultra in pool per installation instructions and/or installation video.

Figure 16

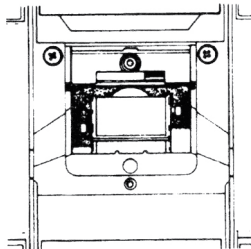

TURBINE/VACUUM CHAMBER



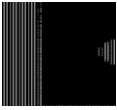

Pool Vac Ultra

TROUBLESHOOTING GUIDE

Problem: Slow/no forward movement

CAUSES	SOLUTIONS
Lack of/improper water flow through cleaner	Check water flow with Flow Gauge and adjust as per Step 6, Figure 2.
Partial blockage of Pool Vac Ultra throat	Clear blockage
Worn shoes	Replace shoes
Worn wings	Replace wings
Improper cleaner model for application	Call 1-800-227-1477 (U.S.A. only)

Problem: Cleaner fails to climb vertical walls gunite/concrete pool

CAUSES	SOLUTIONS
Improper shoes for application	Call 1-800-227-1477 (U.S.A. only)
Lack of/improper water flow through cleaner	Check water flow with Flow Gauge and adjust as per Step 6, Figure 2.
Partial blockage of Pool Vac Ultra throat	Clear blockage
Worn shoes	Replace shoes
Worn wings	Replace wings
Hose too short	Install additional hose sections per installation instructions
Improper tension on rear flap	Turn rear flap adjuster to III

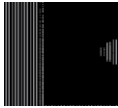

Pool Vac Ultra

TROUBLESHOOTING GUIDE

Problem: Cleaner climbs to water surface and sucks air

CAUSES

Too much/improper water flow through cleaner

Improper tension on rear flap

proper operation is achieved

Steering failure

smoothly in both directions

SOLUTIONS

Check water flow with Flow Gauge and adjust per instructions in Step 6.

Turn rear flap adjuster to l

If still climbing too much, reduce water flow until

1) Check and clean rear screen

2) Check to see that cone gear is free and rotates

3) Check medium turbine and spindle gear assemblies for malfunction

Problem: Cleaner head “floats”

CAUSES

Head buoyancy

the air bubbles and allow the cleaner head to settle

The cleaner head is actually being pulled or lifted off the bottom of the pool by the cleaner hose, of return line flow - either at the surface or at the bottom of the pool - or both

SOLUTIONS

Refer to this manual to ensure enough hose lengths are installed

Remove all air from cleaner head

Stop all air from entering the pool through the return lines

If cleaner head and hose are covered with fine bubbles, give the hose a good tug. This will release

to the bottom of the pool until the hose is covered with bubbles again

Readjust return lines to prevent water flow from interfering with cleaner head and/or hose



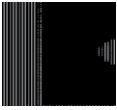

Pool Vac Ultra

TROUBLESHOOTING GUIDE

Problem: Cleaner sticks at steps, corners, etc.

CAUSES

Improper water flow

Worn shoes

Worn wings

Hose too short

Steering failure

smoothly in both directions

REPLACE IF NECESSARY. DO NOT ATTEMPT

SOLUTIONS

Check water flow with Flow Gauge and adjust as per Step 6, Figure 2.

Replace shoes

Replace wings

Install additional hose per installation instructions

1) Check and clean rear screen

2) Check to see that cone gear is free and rotates

3) Check steering program and troubleshoot - then:

a) clean, repair or replace gearbox

b) check pod/A-frame connection and
TO RETIGHTEN LOOSE PODS.

c) check medium turbine and spindle gear
assemblies



Pool Vac Ultra

DISCLAIMER

- A) Pool plaster is affected by age, water chemistry, etc.
- B) Pool plaster can deteriorate over a period of time.
- C) The integrity of “good” pool plaster is such that a pool vacuum cleaner - automatic or manual cannot remove that plaster.
- D) The integrity of “good” pool plaster is such that the plaster will cause wear on the Pool Vac Ultra - not vice versa.
- E) Vinyl is affected by age, sunlight and water chemistry.
- F) Vinyl can become brittle and weak.
- G) Vinyl can also be affected by the installation and the pool's surroundings.
- H) When installing the Pool Vac Ultra, you must assume all responsibility for the condition of the pool and the pool's surroundings.

To better serve you, please have the following information available if you call Hayward's Technical Service Department at 1-800-227-1477 (U.S.A. only):

- 1) The Purchase Date of your Pool Vac Ultra.
 - 2) The Serial Number of your Pool Vac Ultra.
 - 3) The number of Hose Sections used.
 - 4) A current water flow indicator setting (refer to Step 6 , Figure 2).
-

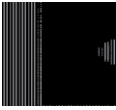

Pool Vac Ultra

CONCRETE, DESERT & VINYL MODEL REPLACEMENT PARTS

Ref.No.	Part No.	Description	No. Req'd
1 a	AXV436LG	Top for Pool Vac Ultra concrete, light gray (exchange only)	1
1b	AXV436BL	Top for Pool Vac Ultra vinyl, elite blue (exchange only)	1
1c	AXV436BK	Top for Pool Vac Ultra concrete, black (exchange only)	1
2a	AXV437	Body, concrete, white	1
2b	AXV447	Body, vinyl, white	1
2c	AXV449	Body, fiberglass, white	1
2d	AXV437BK	Body, concrete, black	1
3	AXV070	Cone gear, clear	1
4	AXV301	Intermediate gear	1
5	AXV309	Intermediate gear shaft	1
6	AXV068	Spindle gear screw	1
7	AXV303	Spindle gear	1
8	AXV066A	Spindle gear bushing	1
9	AXV306	Cone gear bushing	1
10	AXV060LG	Upper middle body, light gray	1
11	AXV065UP	Upper body screw (6 pack)	1
12	AXV064A	Medium turbine drive gear	1
13	AXV062C	Medium turbine	1
14	AXV009	Medium turbine case w/axle	1
15	AXV408P	Gear box assembly	1
16a	AXV051ABK	Rear screen, black	1
16b	AXV051AWH	Rear screen, white	1
17	AXV054P	Float (2 pack)	1
18	AXV050CLG	Lower middle body, light gray	1
19	AXV429WH	Bumper assembly, white	1
20	AXV057P	Middle body screw (6 pack)	1
21	AXV313	Lower body screw (4 pack)	1
22	AXV031B	Flap adjuster	1

COLOR KEY: WH = White, BK = Black, LG Light Gray, EB = Elite Blue

*Special order.



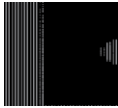

Pool Vac Ultra

CONCRETE, DESERT & VINYL MODEL REPLACEMENT PARTS

Ref.No.	Part No.	Description	No. Req'd
23a	AXV230DBK	Lower body, black	1
23b	AXV230DWH	Lower body, white	1
24a	AXV434BKP	Flap kit, black (2 flaps, front & rear springs)	1
24b	AXV434WHP	Flap kit, white (2 flaps, front & rear springs)	1
25	AXV015P	Pod screw kit, (2 hex head screws & 2 washers)	1
26	AXV016P	Pod plug (6 pack)	1
27a	AXV604BKP	Wing kit, black (right and left wings)	1
27b	AXV604WHP	Wing kit, white (right and left wings)	1
28a	AXV414P	Pod shoes, concrete (4 pack)	1
28b	AXV413P	Pod shoes, vinyl (4 pack)	1
28c	AXV014CP	Pod shoes, ceramic (4 pack)	1
28d	AXV014SP	Pod shoes, slotted (4 pack)	1
29	AXV314P	Captive Screw & Retaining Cli	1
30a	AXV601P	Turbine Kit (includes main turbine and 2 bearings)	1
30b	AXV601D	Turbine Kit Desert (includes main turbine and 2 bearings)	1
31a	AXV603	Fixed access cover ass'y for concrete and desert models (For Model # 2025C)	1
31b	AXV603A	Fixed access cover ass'y for vinyl models (For Model # 2025V)	1
31c	AXV603BK	Fixed access cover ass'y for black concrete & desert model # 2025	1
32a	AXV417WHP	Pod kit, white (right/left pods, plugs, screws & washers)	1
32b	AXV417BKP	Pod kit, black (right/left pods, plugs, screws & washers)	1
33	AXV055P	Turbine bearings (2 pack)	1
34	AXV093CP	Skimmer Cone	1
—	AXV079VP	Medium turbine/spindle gear kit, vinyl (medium turbine, drive gear, bushing, vinyl spindle gear, screw, medium turbine axle, intermediate gear, intermediate gear axle)	1
—	V096P	In-line gauge	1
—	V574P	Flow gauge	1

COLOR KEY: WH = White, BK = Black, LG Light Gray, EB = Elite Blue

*Special order.

Pool Vac Ultra

CONCRETE, DESERT & VINYL MODEL REPLACEMENT PARTS

