

# TECNOJET II s

**0.75 kW; 1.1 kW 50Hz**  
**0.9 kW; 1.3 kW 60Hz**

The standard side channel blowers/aspirators are designed to handle clean air up to a maximum of 40°C. Please contact us for special applications.

Motors construction conform with CEI 2-3 (1988) NORMS. ISOL. CL F PROT. IP 55, cCSAus certified

cCSAus file nr. 242079 

	Articolo Item code	kW	V	Hz	assorb. AMP absorbed AMPS	giri/min. r.p.m.	limite servizio max cont. duty S1 (mbar)	μF/V	dB (A)*	peso (Kg) weight (Kg)
<b>MONOFASE SINGLE-PHASE</b>	046759 CE	0.75	230-240	50	5.5	2850	-135 +135	20 / 450	64	18
	046720 cCSAus	0.75	230-240	50	5.5	2850	-135 +135	20 / 450	64	18
	046758 CE	1.1	200-220	60	8.7	3500	-165 +155	20 / 450	66	18
	046721 cCSAus	1.1	200-220	60	8.7	3500	-165 +155	20 / 450	66	18
<b>TRIFASE THREE-PHASE</b>	046766	0.75	200-240 Δ 345-415 Y	50	4.7 Δ 2.7 Y	2900	-120 +120	-	64	18
	046766	0.9	220-275 Δ 380-480 Y	60	4.3 Δ 2.5 Y	3500	-130 +115	-	66	18
	046731	0.75	220-240 Δ 345-415 Y	50	4.2 Δ 2.4 Y	2900	-145 +140	-	64	18
	046731	0.9	220-275 Δ 380-480 Y	60	4.45 Δ 2.6 Y	3500	-145 +130	-	66	18
	046780	1.1	220-240 Δ 345-415 Y	50	5.2 Δ 3.0 Y	2900	-155 +155	-	64	18
	046780	1.3	220-275 Δ 380-480 Y	60	5.5 Δ 3.2 Y	3500	-185 +185	-	66	18

\* Livello di pressione sonora rilevato secondo le Norme ISO 3746 - 1979 (E). Parametri: r=1 - Rumore di fondo 51 dB (A) - Strumento: Brüel & Kjær type 2232.  
 \* Sound pressure level tested according to ISO regulation 3746 - 1979 (E). Parameters: r=1 - Background noise 51 dB (A) - Instrument: Brüel & Kjær type 2232.

### dimensions:

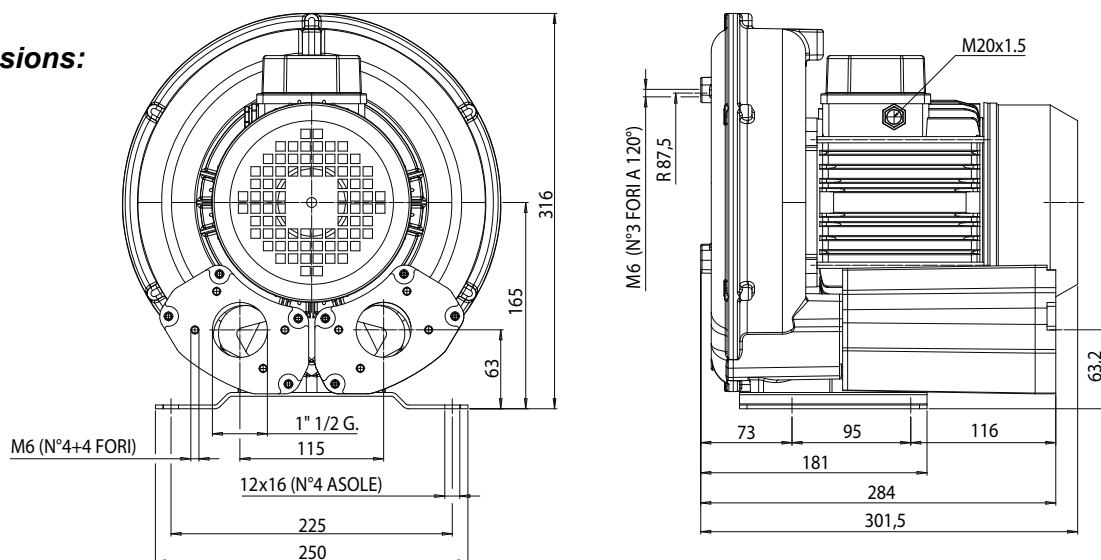

all dimensions are in mm

## VACUUM

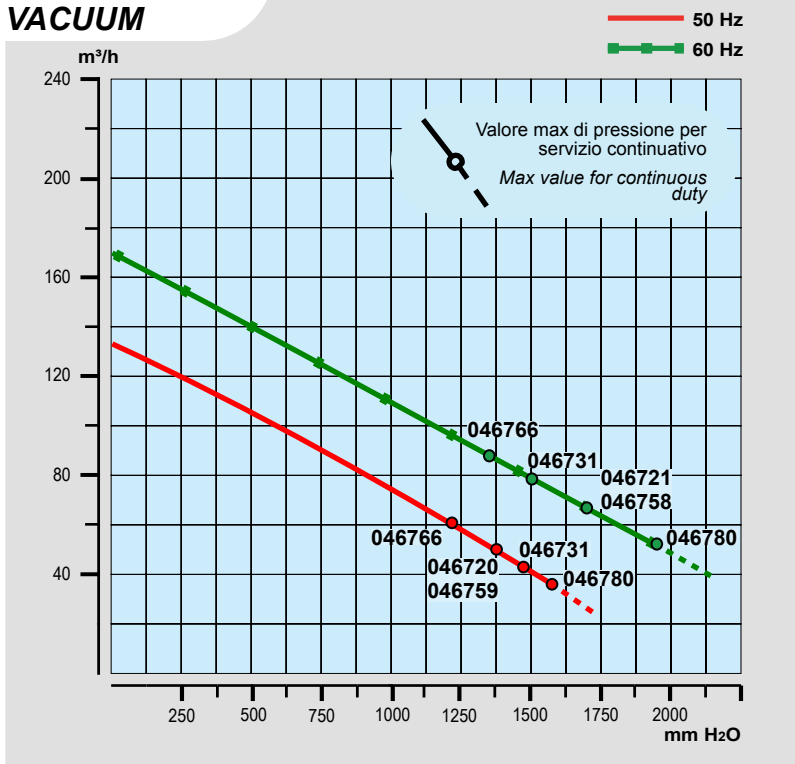

## MOTOR ABSORPTION

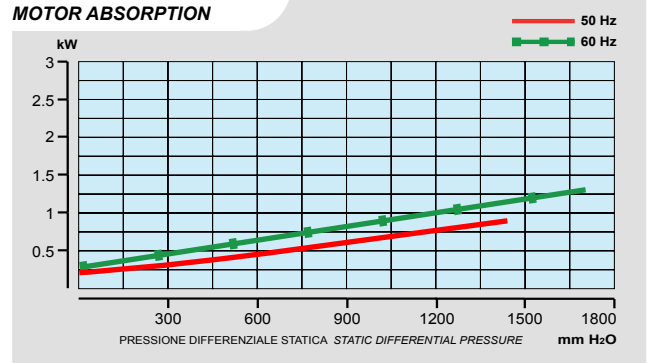

## AIR TEMPERATURE INCREASE

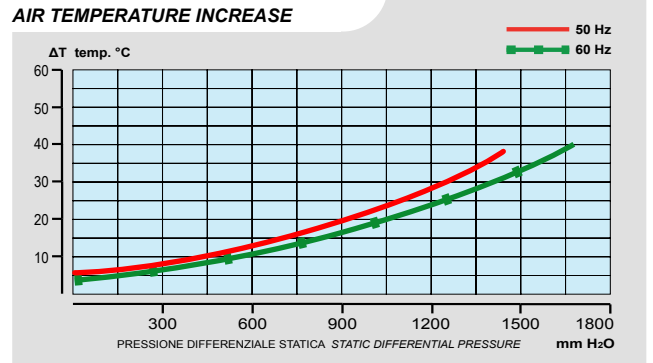

## PRESSURE

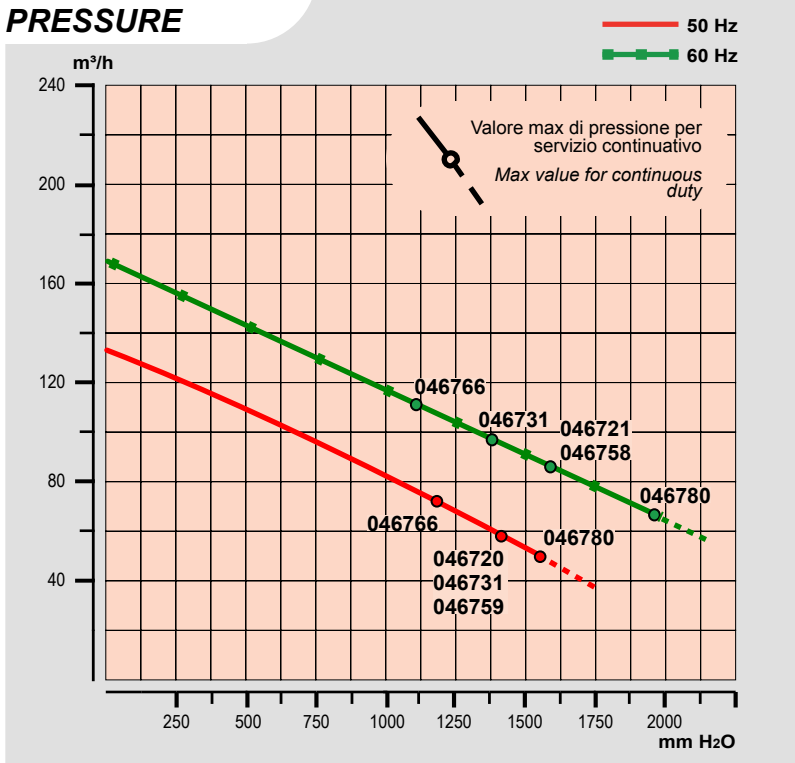

## MOTOR ABSORPTION

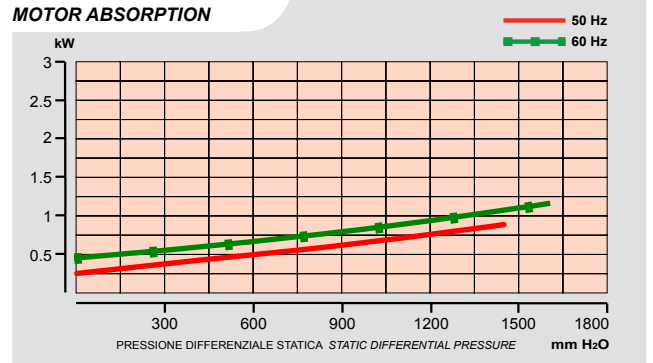

## AIR TEMPERATURE INCREASE

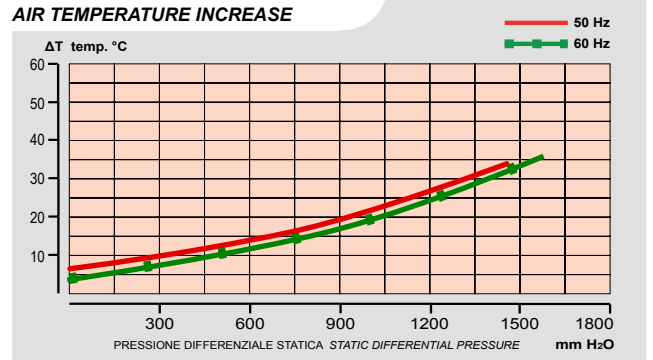

All data is intended as an indication and may be modified without prior notice.

The vacuum curve is valid for pumping air, with a temperature of 20°C at the inlet flange and with a pressure of 1013 mbar at the discharge port.  
The pressure curve is valid for pumping air, with an average temperature of 20°C and 1013 mbar at the inlet flange.

l/min = m³/h · 16,667  
CFM = m³/h · 0,588  
mbar = mm H2O · 0,098  
PSI = mm H2O · 0,00142



### Rainbow Pool Products

PO Box 2388, Mansfield Qld 4122  
Telephone STD 61-7-3849 5385  
Facsimile STD 61-7-3849 5384  
Email: info@rainbowpoolproducts.com.au  
Web: www.rainbowpoolproducts.com.au