



IntelliTouch® Pool and Spa Control System User's Guide



IMPORTANT SAFETY INSTRUCTIONS
READ AND FOLLOW ALL INSTRUCTIONS
SAVE THESE INSTRUCTIONS



© 2011 Pentair Water Pool and Spa, Inc. All rights reserved

This document is subject to change without notice

1620 Hawkins Ave., Sanford, NC 27330 • (919) 566-8000
10951 West Los Angeles Ave., Moorpark, CA 93021 • (805) 523-2400

IntelliTouch®, MagicStream®, ScreenLogic®, IntelliChlor®, IntelliFlo®, SpaCommand™, MobileTouch®, QuickTouch®, IntelliBrite®, SAm®, SAL®, FIBERworks®, Amerlite®, SpaBrite®, Photon Generator®, UltraTemp®, IntelliChem®, Pentair Pool Products®, and Pentair Water Pool and Spa® are trademarks and/or registered trademarks of Pentair Water Pool and Spa, Inc. Aqua Rite® is a registered trademark of Hayward Industries, Inc. AutoClear® is a registered trademark of Zodiac Pool Care. Crestron® is a registered trademark of Crestron Electronics. Liton® is registered trademark of Eema Industries, Inc. and Pool Pilot® is a registered trademark of Autopilot Systems Inc. Unless noted, names and brands of others that may be used in this document are not used to indicate an affiliation or endorsement between the proprietors of these names and brands and Pentair Water Pool and Spa, Inc. Those names and brands may be the trademarks or registered trademarks of those parties or others.

Contents

Important Warning and Safety Instructions	v
In this User's Guide	vi
Technical Support	vi
Related IntelliTouch Manuals	vi
SECTION 1 - INTELLITOUCH SYSTEM OVERVIEW	1
Introduction	1
IntelliTouch System Overview	1
In the home	1
Around the pool	1
At the equipment pad	1
IntelliTouch in your home	3
IntelliTouch System Components	4
Load or Power Center	4
IntelliTouch Personality Kits	4
IntelliTouch Personality Kit Contents	4
ScreenLogic Interface Kits	5
Optional Equipment (IntelliChem)	5
iPhone/iPad Touch Inteliface Kit (P/N 520500)	6
In-Wall Touch Screen (iTC35 Kit - P/N 520502)	6
Digital Wireless Tablet (iTC45 Kit - P/N 520503)	6
IntelliTouch ScreenLogic Interface Accessory Kits	6
SECTION 2 - OPERATING THE INTELLITOUCH SYSTEM	7
Main Screen (Indoor Control Panel and MobileTouch wireless control panel)	7
IntelliTouch Menus	8
IntelliTouch Indoor Control Panel Menus	9
Heating your Spa and Pool	10
Adjust Spa or Pool Heat Settings	10
Selecting the Heating System	11
Switching on Lights Manually	12
Special Lighting Features	13
Dimming Lights	14
Setting ON/OFF Times for Equipment (PROGRAM)	14
Smart Start (Setting up SAm, SAL and IntelliBrite lights)	15
Using the Once Only Timer	16
Setting the Egg Timer Function	17
iS10 Spa-Side Remote Controller	18
iS4 Spa-Side Remote Controller	19
MobileTouch Wireless Controller	19
Charging the MobileTouch Wireless Controller	20
Using the MobileTouch Wireless Controller	20
QuickTouch Wireless QT4 Remote Controller	21
IntelliChlor Salt Chlorine Generator (Accessory)	21
IntelliFlo VF 3050 Variable Flow Pump (Accessory)	22
IntelliFlo VS 3050 Variable Speed Pump (Accessory)	22
IntelliFlo VSF+SVRS Variable Speed Pump (Accessory)	22

Contents (Continued)

SECTION 3 - PREPARING THE SYSTEM FOR INITIAL START-UP	23
Setting up the IntelliTouch System	23
Wired Controllers (Automatically Enabled).....	25
Adding Multiple SpaCommand) Spa-Side Remotes and Expansion Centers	25
Adding a MobileTouch Wireless Controller	25
Manually Enabling Expansion Centers.....	26
Assigning Additional Expansion Centers	27
Setting up the MobileTouch Wireless Controller	28
Adding a SpaCommand Spa-Side Remote	30
Prepare the System for Operation	31
Checking the Main Load Center	31
Setting up the IntelliTouch System using the Indoor Control Panel or MobileTouch	33
The Preference Screen Options.....	33
Set the System Clock	34
Assigning Circuit Names (for Display 1, 2, 3, and 4)	34
Selecting DISPLAY Screen 1, 2, 3, or 4.....	35
Assigning Circuit Names.....	35
Selecting the Display Screens	36
IntelliTouch Circuit Names.....	37
Creating Custom Names for Auxiliary Circuits	38
Assign Circuit Functions and Freeze Protection	39
Freeze Protection	39
Assigning a function and freeze protection to a circuit.....	39
Special Functions for Circuits	41
Setting up Lighting Options (Color Swim and Color Set).....	42
Color Swim and Color Set	42
Setting up Color Swim and Color Set with SAm, SAL, or FIBERworks	42
Setting up Color Swim and Color Set lights.....	42
Setting up IntelliBrite LED lights	46
Selecting IntelliBrite Modes	48
Modes screen	48
Modes: Color light shows	48
Feature: Swim	48
Feature: Color set.....	49
Fixed Colors Screen	49
Fixed Colors: Hold/Recall Feature	49
Setting up MagicStream Laminars	50
Using the MagicStream Laminar Features.....	52
Setting up Equipment (from the Equipment Screen)	53
Manual Priority Override of Timed Program Circuits	53
Chlorine Generator.....	54
Activating the Chlorinator	54
Adjusting the Chlorine Output Level	54
Super Chlorinate the Pool Water.....	55
IntelliFlo VF 3050, VS 3050 and VSF+SVRS Pump Setup.....	56
Setting up IntelliFlo	56
How many pumps will IntelliTouch support?	56
Connecting power to an IntelliFlo pump.....	56
Assigning an IntelliFlo VF 3050 pump address	56

Contents (Continued)

IntelliFlo Menu Options	57
IntelliFlo pump type and assignment screens	57
IntelliFlo VF 3050 Pump Setup	58
IntelliFlo Set Parameters screens	58
Assign or change a pump circuit name	58
Filtering parameters	59
Priming parameters	60
Backwash parameters	61
Vacuum parameters	62
Assign custom flows	63
IntelliFlo status screen	64
IntelliFlo VS 3050 and VSF+SVRS Pump Setup	65
Setting up IntelliFlo VS 3050 and VSF+SVRS	65
Assigning an IntelliFlo VS 3050 pump address	65
Assigning an IntelliFlo VSF+SVRS pump address	65
Setting up an IntelliFlo VS 3050 and VSF+SVRS pump from Equipment Screen	66
Priming Parameters (IntelliFlo VS 3050)	67
Assign custom speeds (RPM) IntelliFlo VS 3050)	68
Assign custom speeds (RPM/GPM) IntelliFlo VSF+SVRS	69
IntelliFlo VS 3050 and IntelliFlo VSF+SVRS4 Status Screen	71
Setting up an UltraTemp Heat Pump	72
UltraTemp heat pump screen (HEATPUMPCOM)	72
Setting up IntelliChem Water Chemistry Controller	73
Setup Solar Equipment and Heat Pump Option	74
Setting up solar equipment	74
Setting up a heat pump and gas heater	74
Setting up a 2-Speed Pump	75
Delay for Valves and Pumps (Heater Cool-Down Cycle)	75
Delay Cancel Feature	76
Spa Options	77
Set Automatic Spa Heating When the Spa is Manually Switched On	77
Freeze Override (30-240 minutes)	77
Changing the Display to Show Fahrenheit to Celsius	77
Configuring Valve Actuators (Controlled by AUX or Feature Circuit)	78
Feature Circuits	79
Assign a Circuit Name to a Feature Circuit	79
Creating a Macro Circuit	80
Configuring Remote Control Button Circuits (iS4, SpaCommand, Spa Side Remote, QT4 QuickTouch, and Phone Remote)	81
Setting up the Remote Control Telephone Feature	82
Disable/Enable Spa-Side Remote	83
Keypad Lock	83
SECTION 4 - SERVICE AND MAINTENANCE	84
Calibrating Temperature Sensors	84
Using the Service Personnel Screen	85
Checking Firmware Version	85
Manually Updating Between Indoor and Outdoor Control Panels	86
Erasing the System Memory	87
System Worksheet Overview	88

Contents (Continued)

SECTION 4 - SERVICE AND MAINTENANCE (Continued)

Main Outdoor Control Panel	95
Shared Equipment Systems Model i5+3, i7+3, i9+3	95
Single Body Systems Model i5S+3, i9+3S	96
Dual Body Dual Equipment Systems Model i10+3	96
Expansion Centers Model i5x, i10x	96
Erasing outdoor Control Panel Memory (Factory Default)	97

SECTION 5 - TROUBLESHOOTING 98

System Start-Up	98
Check Electronics	98
System Test	98
Troubleshooting	99
Frequently Asked Questions (FAQ)	99
What does a '+3' IntelliTouch system mean?	99
How Do I Setup/Configure/Program the 2-Speed Pump?	99
Can I turn the Heater On and Change the temperature from the Spa?	99
How do I get Solar to switch on?	99
What are Color Swim and Color Set?	100
How do I get SAM/SAL/PG2000 to Synchronize?	100
Can I copy a standard configuration to all the systems I install?	100
Fixing mismatched system personalities	101
Indoor Control Panel and Outdoor Control Panel Connection Problem	101
MobileTouch Temperature Readout Not Accurate (20 to 30 Degrees off)	101
System Problem Diagnosis	102
Problem: The system works in Service Mode, but Indoor Control Panel fails to operate.	102
Problem: Indoor and Outdoor Control Panels work, but iS4 fails to operate.	103
Problem: Indoor and Outdoor Control Panels work, but iS10 fails to operate.	104
Problem: The Mobile Control Panel will not work, or will not work dependably.	105
Problem: The Quick Touch remote will not work, or will not work dependably.	106
IntelliFlo Alerts and Warnings	108
Suction Blockage	108
IntelliFlo VS 3050 and IntelliFlo VSF+SVRS Warning and Alarm Conditions	109
Alarm and warning LED sequence	109
IntelliTouch Power Center Wiring Diagram	110
IntelliTouch Load Center Wiring Diagram	111
Wiring IntelliTouch to a Salt Chlorine Generator	112
Wiring UltraTemp to IntelliTouch	112

Glossary 113

IMPORTANT WARNING AND SAFETY INSTRUCTIONS



Important Notice:

Attention Installer: This manual contains important information about the installation, operation and safe use of this product. This information should be given to the owner and/or operator of this equipment.

⚠ WARNING - Before installing this product, read and follow all warning notices and instructions which are included. Failure to follow safety warnings and instructions can result in severe injury, death, or property damage. Call (800) 831-7133 for additional free copies of these instructions.

⚠ DANGER - Water temperature in excess of 100° F (37.7° C) may be hazardous to your health. Prolonged immersion in hot water may induce hyperthermia. Hyperthermia occurs when the internal temperature of the body reaches a level several degrees above normal body temperature of 98.6° F (37° C.). Effects of hyperthermia include: (1) Unawareness of impending danger. (2) Failure to perceive heat. (3) Failure to recognize the need to leave the spa. (4) Physical inability to exit the spa. (5) Fetal damage in pregnant women. (6) Unconsciousness resulting in danger of drowning. The use of alcohol, drugs, or medication can greatly increase the risk of fatal hyperthermia in hot tubs and spas.

⚠ WARNING - To reduce the risk of injury, do not permit children to use this product unless they are closely supervised at all times.

⚠ WARNING - **The use of alcohol, drugs, or medication can greatly increase the risk of fatal hyperthermia in hot tubs and spas.**

⚠ WARNING - GAS HEATER: The IntelliTouch® automation control system is designed to supply high voltage (120 VAC / 240 VAC) to a gas heater and override the thermostat in the heater's control circuit. This automation control system is intended to control gas heaters with a high temperature limit switch(s) safety circuit ONLY. Failure to do so may cause property damage or personal injury.

⚠ WARNING - Do not use this product to control an automatic pool cover. Swimmers may become entrapped underneath the cover.

⚠ WARNING - For units intended for use in other than single-family dwellings, a clearly labeled emergency switch shall be provided as part of the installation. The switch shall be readily accessible to the occupants and shall be installed at least (5) feet (1.52 m) away, adjacent to, and within sight of, the unit.

⚠ CAUTION - Except for listed spa-side remote controls, install a minimum of five (5) feet (1.52 m) from the inside wall of the pool and spa.

⚠ CAUTION - This product is intended for use in swimming pool applications only.

Two Speed Pump Controls Notice (Title 20 Compliance)

Please read the following important Safety Instructions (See page 75 pump speed setup)

When using two-speed pumps manufactured on or after January 1, 2008, the pump's default circulation speed MUST be set to the LOWEST SPEED, with a high speed override capability being for a temporary period not to exceed one normal cycle, or two hours, whichever is less.

IMPORTANT WARNING AND SAFETY INSTRUCTIONS

⚠ FCC Regulatory Safety Notice - The IntelliTouch wireless control panel device has been tested and found to comply with the **FCC Standard** - 47 CFR Part 15, Subpart C (Section 15.247). This version is limited to chapter 1 to chapter 11 by specified firmware controlled in the U.S.A.

Canada - Industry Canada (IC) - The IntelliChlor device complies with RSS210 of Industry Canada. (1999). Operation is subject to the following two conditions: (1) this device may not cause interference, and (2) this device must accept any interference, including interference that may cause undesired operation of the device.

Instruction to user - The IntelliChlor device has been tested and found to comply with the limits for a Class B digital device, pursuant to Part 15 of the FCC Rules. These limits are designed to provide reasonable protection against harmful interference in a residential installation. The IntelliChlor device generates, uses and can radiate radio frequency energy and, if not installed and used in accordance with the instructions, may cause harmful interference to radio communications. However, there is no guarantee that interference will not occur in a particular installation. If this device does cause harmful interference to radio or television reception, which can be determined by switching the device off and on, the user is encouraged to try to correct the interference by one or more of the following measures:

- Reorient or relocate the receiving antenna.
- Increase the separation between the equipment and receiver.
- Connect the equipment into an outlet on a circuit different from that to which the receiver is connected.
- Consult the dealer or an experienced radio/TV technician for help.

General Installation Information

1. All work on the IntelliTouch® load/power center must be performed by a licensed electrician, and must conform to all national, state, and local codes.
2. Install to provide drainage of compartment for electrical components.
3. If this system is used to control underwater lighting fixtures, a ground-fault interrupter (GFCI) must be provided for these fixtures. Conductors on the load side of the ground-fault circuit-interrupter shall **not** occupy conduit, junction boxes or enclosures containing other conductors unless such conductors are also protected by a ground-fault circuit-interrupter. Refer to local codes for details.
4. A terminal bar stamped  is located inside the supply terminal box. To reduce the risk of electric shock, this terminal must be connected to the grounding means provided in the electric supply service panel with a continuous copper wire equivalent in size to the circuit conductors supplying this equipment (no smaller than 12 AWG or 3.3 mm). The bonding lug(s) provided on this unit are intended to connect a minimum of one No. 8 AWG for US installation and two No. 6 AWG for Canadian installations solid copper conductor between this unit and any metal equipment, metal enclosures or electrical equipment, metal water pipe, or conduit within 5 feet (1.5 m) of the unit.
5. The electrical supply for the IntelliTouch® load/power center must include a suitably rated switch or circuit breaker to open all ungrounded supply conductors to comply with in accordance with the National Electrical Code (NEC), NFPA 70 or the Canadian Electrical Code (CEC), CSA C22.1. All applicable local installation codes and ordinances must also be adhered to. The disconnecting means must be readily accessible to the tub occupant but installed at least 10 ft. (3.05 m) from the inside wall of the pool.
6. **GAS HEATER:** The IntelliTouch® automation control system is designed to supply high voltage (120 VAC / 240 VAC) to a gas heater and override the thermostat in the heater's control circuit. This automation control system is intended to control gas heaters with a high temperature limit switch(s) safety circuit **ONLY**. Failure to do so may cause property damage or personal injury.
6. Supply conductor for the IntelliTouch® load/power center must be sized to support all loads. Maximum supply conductor current must be 150 Amps at 120 VAC / 240 VAC.

For information about the Virginia Graeme Baker Pool and Spa Safety Act, contact the Consumer Product Safety Commission at (301) 504-7908 or visit www.cpsc.gov.

NOTE: Always turn off all power to the pool pump before installing the cover or working on any suction outlet.

Blank Page

In this User's Guide

This User's Guide describes how to operate the IntelliTouch® pool and spa control system.

This manual consists of the following sections:

Section 1: IntelliTouch System Overview	(page 1)
Section 2: Operating the IntelliTouch System	(page 7)
Section 3: Preparing the System for Initial Start-Up	(page 23)
Section 4: Service and Maintenance	(page 81)
Section 5: Troubleshooting	(page 95)

Technical Support

Sanford, North Carolina (8 A.M. to 5 P.M. ET.)

Moorpark, California (8 A.M. to 5 P.M. PS.)

Phone: (800) 831-7133

Fax: (800) 284-4151

Web sites

<http://www.pentairpool.com> and [staritepool.com](http://www.staritepool.com)

Download the IntelliTouch User's Guide (PDF) from the Web

<http://www.pentairpool.com/pdfs/IntelliTouchUG.pdf>

Related IntelliTouch Manuals

IntelliTouch Personality Kit User's Guide	(P/N 521074)
IntelliTouch Load Center and Power Center Installation User's Guide	(P/N 521139)
IntelliTouch i-Link Protocol Interface Adapter User's Guide	(P/N 520450)
ScreenLogic® User's Guide	(P/N 520493)
ScreenLogic® Video & Lighting Protocol Adapter User's Guide	(P/N 520936)
IntelliChlor Installation and User's Guide	(P/N 520589)
IntelliChem Installation and User's Guide	(P/N 521363)

IntelliTouch® System Overview

Introduction

Welcome! Your Pentair Pool and Spa® (“Pentair”) IntelliTouch® Control System will change the way you view pool and spa controls. This innovation in pool and spa automation offers complete freedom for you while having full automation control over your pool, spa, lights, heater, pump, cleaners and much more. You can now schedule multiple start and stop times to control your lights, heater, spa jets, and filter pumps. Using the IntelliTouch® Indoor Control Panel or IntelliTouch MobileTouch® wireless control panel you can control your pool, spa, and lights from anywhere inside or outside of your home. Optional controllers are also available such as the wireless Digital Tablet, iPhone, iPad or iPod Touch interface (purchased separately), and in-wall Touch Screen that can interface with your PC. IntelliTouch is a scalable system that can be upgraded to a completely integrated home automation solution including audio, security, climate, irrigation and more. For more information about using these interfaces, refer to the ScreenLogic2™ Interface Kits on page 5.

IntelliTouch System Overview

An IntelliTouch system can include five (5) to 40 high voltage relays circuits that can be used to control any combination of pumps, lights, water features. A maximum of ten (10) relays can be housed in an IntelliTouch Load Center or Power Center. Up to three (3) Load Centers or Power Centers can be connected to a main Load Center for a maximum of 40 relays. User-configurable circuits can be used to control equipment. The “Feature Macro” circuits feature allows any number of circuits to be combined and controlled by a single button.

An optional IntelliTouch Dimmer Module (P/N 520406) can be installed for use to dim any high voltage incandescent light such as Pentair Amerlite® and Pentair SpaBrite® lights. The dimmer module supports multiple lights from 100 watts up to 1,000 watts and installs in a standard relay location. Any number of dimmers (up to 10 maximum) may be used with a maximum combined load of 4,000 watt in a single Load Center.

In the home

The IntelliTouch system can utilize multiple wired and wireless controllers including the Digital Tablet, iPhone or iPad Touch interface (purchased separately), the wired in-wall Touch Screen, Indoor Control Panel, and the wireless MobileTouch® remote control panel. Your existing home PC can also be used to control the IntelliTouch system via the ScreenLogic2 interfaces. A maximum of four (4) ScreenLogic2 interfaces can be used, for example, four Tablets or four in-wall Touch Screen’s, or four PC’s in any combination.

Around the pool

The IntelliTouch, SpaCommand® and iS4 spa-side remote provide control buttons for various pool and spa functions. The SpaCommand spa-side remote also provides a temperature display.

At the equipment pad

The pool pump, filter, and various IntelliTouch remote controllers and interfaces are connected to the IntelliTouch Load Center and/or Power Center enclosure which are located at the equipment pad. The Load Center enclosure is where the high voltage lines from the circuit breaker panel junction box at the home are connected to. The pool service person can periodically check pool operations from the Load Center. Also at the equipment pad there are system pool and spa pipes connected to the pump, heater and filtration system. Mounted on top the valves are motorized valve actuators (with attached 25 ft cable for wiring) used to automatically change the direction flow of water through the plumbing system. There are also temperature sensors and a cable that connects to the heater.

IntelliTouch System Components

The main required components of an IntelliTouch system is a Load Center or Power Center, IntelliTouch Personality Kit, and Interface:

- **iPhone™/iPad® Touch Interface (P/N 520500)** – Includes Protocol Interface Adapter that connects to existing Desktop or Laptop PC. This allows control of IntelliTouch pool and spa systems via PC (requires PC with an Ethernet connection, and Windows® XP operating system).
- **iTC35 Kit (P/N 520502)** – Includes in-wall color touch screen with Ethernet (RJ45) connection and Protocol Interface Adapter and wireless router. The in-wall Touch screen is custom configured for IntelliTouch systems. Requires an Ethernet cable to router.
- **iTC45 Kit (P/N 520503)** – Includes wireless Tablet with color touch screen, Protocol Interface Adapter, and wireless router. The Tablet is custom configured for IntelliTouch systems.



iPhone™
(for use with ScreenLogic2™)



In-Wall Touch Screen



Digital Tablet



Indoor Control Panel

- **Indoor Control Panel (P/N 520138)** – 3.75” monochrome backlit LCD control panel. Connects to the IntelliTouch Personality board in the Load Center.
- **MobileTouch® Kit (P/N 520906)** – 3.75” monochrome backlit LCD wireless control panel with Transceiver antenna. Allows any IntelliTouch wired system to also have a wireless remote with all the capabilities of the Indoor Control Panel. With an average range of 300 feet, pool owners have system control anywhere around the home or yard. Powered by a rechargeable lithium-ion battery. Includes a cradle for recharging. The MobileTouch control panel without the Transceiver antenna (P/N 520907) is also available.
- **QuickTouch® II (P/N 521245) and QT4 (P/N 520148) Wireless Remote:** Four-function wireless remote for pool and spa functions of your choice. This controller transmitter operates up to 150 feet range from the Load Center or Power Center.
- **SpaCommand® (P/N 521176):** 10-function (SpaCommand™) and 4-function (iS4) spa-side remote controller for pool and spa functions of your choice. The controllers can operate up to 150 feet range from the Load Center or Power Center.



MobileTouch® Wireless Controller



SpaCommand™



QuickTouch® II wireless remote

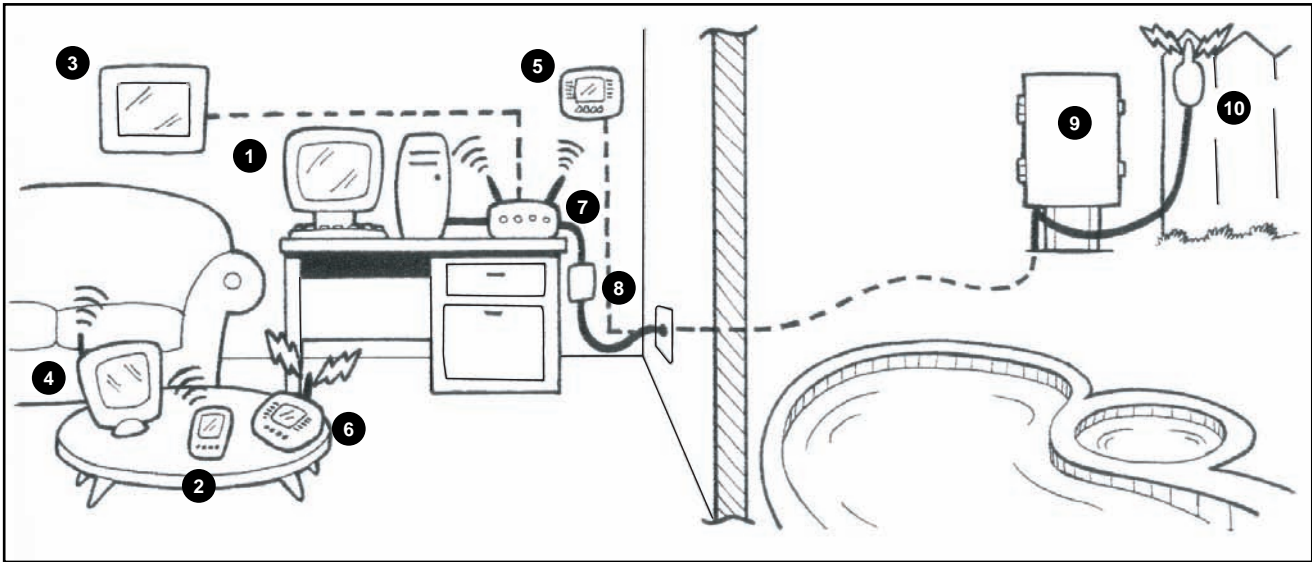

IntelliTouch in Your home

- 1 **Personal Computer (PC):** Existing home owner's PC or Laptop. Connects to a wireless router and the IntelliTouch Protocol adapter for control of IntelliTouch pool/spa systems. Requires a PC/Laptop (Windows XP) with Ethernet/RJ45 adapter installed.
- 2 **Personal Digital Assistant (PDA):** This wireless PDA with a color touch screen enables you to control your pool and spa features using the IntelliTouch ScreenLogic interface. The PDA is custom configured for IntelliTouch systems.
- 3 **In-wall Touch Screen:** A color display with Ethernet (RJ45) connector. Connects to the provided wireless router and Protocol adapter via Ethernet (RJ45) for control of IntelliTouch pool and spa systems. The in-wall Touch Screen is custom configured for IntelliTouch systems.
- 4 **Wireless Tablet:** This control panel consists of a color touch screen. Receives and transmits commands via wireless router and Protocol adapter for control of IntelliTouch pool/spa systems. The Tablet is custom configured for IntelliTouch systems.
- 5 **Indoor Control Panel:** This control panel consists of a 3.75" monochrome backlit LCD and connects to the Personality Board in the Load Center or Power Center for control of IntelliTouch pool and spa systems.
- 6 **MobileTouch:** This wireless control panel has a 3.75" monochrome backlit LCD. Receives and transmits commands via the Transceiver antenna located at the Load or Power Center.
- 7 **Wireless router:** Connects to the PC or Laptop via Ethernet connection to the Protocol adapter.
- 8 **Protocol adapter:** Connects to wireless router via Ethernet connection and to Personality board (Load/Power Center) via a four-wire 22-AWG cable.
- 9 **Load Center or Power Center.** The main control center. Includes the Outdoor Control Panel that controls pump, heater, and light relays. Receives commands via Protocol adapter, and wireless and wired control panels connected to the Personality board.
- 10 **MobileTouch Transceiver antenna:** Connects to the Personality circuit board. Sends and receives commands to and from the MobileTouch wireless control panel.

Tools required

- 3/16 in. diameter drill (for mounting Indoor Control Panel).
- 5/16 in. diameter drill (for mounting Water Temperature Sensor).

IntelliTouch System Components

The main required components of an IntelliTouch system is a Load Center or Power Center, IntelliTouch Personality Kit, and Interface:

IntelliTouch System Components

The main required components of an IntelliTouch system is a Load Center or Power Center, IntelliTouch Personality Kit, and Interface:

Load or Power Center

- **Load Center:** Provides a larger footprint (26" H x 17" W x 5-1/4" D) Includes built-in sub panel (150 AMPS) capable of holding up to eight 1" breakers. Also includes five 25 AMP three HP relays, 110/240 V transformer with secondary side circuit protection. Multiple knockouts for different sizes of conduit are supplied as well as a GFCI side knockout. The Load Center provides ample space for all high and low voltage wiring needs.
- **Power Center:** Offers a smaller footprint (20" H x 17" W x 5-1/4" D) than the Load Center. The Power Center does not include a circuit breaker base. Users should choose this enclosure if they already have existing circuit breakers/sub-panel for their equipment.

IntelliTouch Personality Kits

There are several types of IntelliTouch control systems available for different pool/spa configurations:

- **Shared Equipment: Pool and spa combinations with shared filtration system** – Pool owners can enjoy the convenience of motorized valves for water flow separation between pool and spa. The Personality Kit models are:
 - **i5+3 (P/N 521219)** – Four auxiliary circuits plus filter pump operation (create a Feature circuit for valve actuators without using an existing output auxiliary circuit, and special light functions for color lighting). Five relays are included in the Load Center.
 - **i7+3 (P/N 521220)** – Six auxiliary circuits plus filter pump operation and the +3 option (create a Feature circuit for valve actuators without using an existing output auxiliary circuit, and special light functions for color lighting). Two relays are included in the kit and five in the Load Center.
 - **i9+3 (P/N 521221)** – Eight auxiliary circuits plus filter pump operation and the +3 option (create a Feature circuit for valve actuators without using an existing output auxiliary circuit, and special light functions for color lighting). Four relays are included in the kit and five in the Load Center.
- **Dual Equipment: Pool and Spa with Dual Sets of Equipment** – The IntelliTouch i10+3D (P/N 521222) is designed to operate two sets of pool equipment. Each set of a equipment (Pool or Spa) can control one temperature setting. This IntelliTouch Personality Kit can control up to 10 pumps and/or lighting circuits, plus two heater circuits. The Personality Kit includes, eight auxiliary circuits plus a filter pump.

The +3 option (create a Feature Macro circuit for valve actuators without using an existing output auxiliary circuit). Five relays are included in the kit and five in the Load Center. You can create a Feature circuit for valve actuators without using an existing output auxiliary circuit, and special light functions for color lighting.

- **Single Equipment: Pool Only or Spa Only Applications** – The IntelliTouch i5S+3 (P/N 521219) and i9+3S provide advanced automation for a single body of water. The i5+3S (P/N 521223) and i9+3S (P/N 521224) Personality Kits includes four auxiliary circuits plus filter pump operation. Five relays are included in the Load Center. The i9+3S Personality Kits includes eight auxiliary circuits plus filter pump operation and the +3 option (create a Feature Macro circuit for valve actuators without using an existing output aux circuit). Four relays are included in the kit and five in the Load Center. You can create a Feature circuit for valve actuators without using an existing output auxiliary circuit, and special light functions for color lighting. This model also allows HI-TEMP and LO-TEMP settings.

IntelliTouch Accessory Power Center Expansion Kits

- **Expansion Kits:** Models i5X (P/N 521225) and i10X (P/N 521226), offer five or ten additional Auxiliary Circuits for systems i9+3, i9+3S and i10+3D. Each IntelliTouch Expansion Kit requires a Load Center (P/N 521213) or Power Center (P/N 521214). Up to three Expansion Kits and Load or Power Centers may be added to a system, for control of up to 38 Auxiliary Circuits (40 auxiliary circuits for i10+3D).

IntelliTouch Personality Kit Contents

The following items are included in the IntelliTouch Personality Kit.

- An IntelliTouch interface
- Outdoor Control Panel. Includes a main controller circuit board and a Personality circuit board.
- Power Relays - (Models i5+3, i5S+3 no relays, i7+3 Qty. 2, i9+3, i9+3S Qty 4, i10+3D Qty 5, i5x (no relays, i10x (5 relays)
- Valve Actuators - Qty 2 (Models i5+3, i7+3, i9+3)
- Temperature Sensors - Water Sensor (with long cable, including o-ring and hose clamp), Air Sensors (with short cable). For i10+3D only, two Water Sensor (with long cable)
- Wiring Diagram Label for models i5S+3 and i9+3S and i10+3D. For models i5+3, i7+3, i9+3, refer to the Load Center and Power Center inside front door.
- Load Center or Power Center parts bag: Includes relay screws (see page 2).
- Label Sheet - A set of adhesive labels for custom identification (used to label the outdoor control panel buttons). Use a pair of fine-tip tweezers to remove the labels from the sheet.
- IntelliTouch Personality Kit Installation Guide (P/N 521074).

Note: For information about the IntelliTouch Indoor Control Panel and MobileTouch® Wireless Controller, refer to the IntelliTouch System User's Guide (P/N 521075).

Optional Equipment (IntelliChem)

- IntelliChem® no-pump (P/N 521357), one-pump (P/N 521356), two-pump (P/N 521355)
- IntelliChem Installation and User's Guide (P/N 521363)



IntelliChem® Water Chemistry Controller (P/N 521356)

ScreenLogic2 Interface Kits

The following items are included in your ScreenLogic2 Kit.

iPhone/iPad Touch Interface Kit (P/N 520500)

- Protocol adapter for use with existing Desktop or Laptop PC, iPhone, iPod Touch, or iPad
- ScreenLogic2 User's Guide
- CD-ROM containing ScreenLogic2 PC user interface software

In-Wall Touch Screen (iTC35 Kit - P/N 520502)

- In-wall Touch Screen, Cradle, and AC adapter.
- Protocol adapter.
- ScreenLogic2 User's Guide (this manual).
- CD-ROM containing ScreenLogic2 PC user interface software.

Digital Wireless Tablet (iTC45 Kit - P/N 520503)

- Digital Tablet (with internal battery pack), stylus, built-in Wi-Fi 802.11b wireless LAN adapter with antenna.
- Protocol adapter.
- ScreenLogic2 User's Guide (this manual).
- CD-ROM containing ScreenLogic2 PC user interface software.

ScreenLogic2 Interface Accessory Kits

If you need additional interfaces, first order one of the ScreenLogic2 interface kits listed above, then order one or more of the following accessory interfaces accessory kits:

- In-Wall Touch Screen, CD-ROM and manual (P/N 520498)
- Tablet, CD-ROM and manual (P/N 520499)

Note: The above Accessory Kits interfaces utilize the existing protocol adapter supplied in the 520500 - 520503 kits.

IntelliTouch Accessories

- 521225 i5X Expansion Kit five Auxiliaries.
- 520906 MobileTouch Wireless Control Panel and Transceiver.
- 520355 Colored Faceplate Kit for surface-mount. Tan, Grey, or Black with label set.
- 520354 Colored Faceplate Kit for recessed-mount. Tan, Grey, or Black with label set.
- 520335 Mud box recessing SpaCommand into deck or tile.
- 520138 Indoor Control Panel, White.
- 520198 Two-Speed Three HP Relay up to three additional valve actuators.
- 520285 Valve module for controlling three additional actuators.
- 520106 Three HP Power Relay.
- 687000 Two Telephone remote control for any single circuit, usually Spa mode.
- 520148 QuickTouch II Four-Function Wireless Remote Kit, Transmitter and Receiver.
- 520406 Dimmer Module. Supports up to 4,000 Watts maximum load (four dimmers handling 1,000 Watts each).
- 520442 i-Link Home Automation Adapter Interface for IntelliTouch.
- 520403 Dual Heater Kit. Utilize a gas heater and heat pump.

Section 2

Operating the IntelliTouch System

Main Screen

(Indoor Control Panel and MobileTouch Wireless Control Panel)

Note: For information about the KEYPAD LOCK feature, see page 80

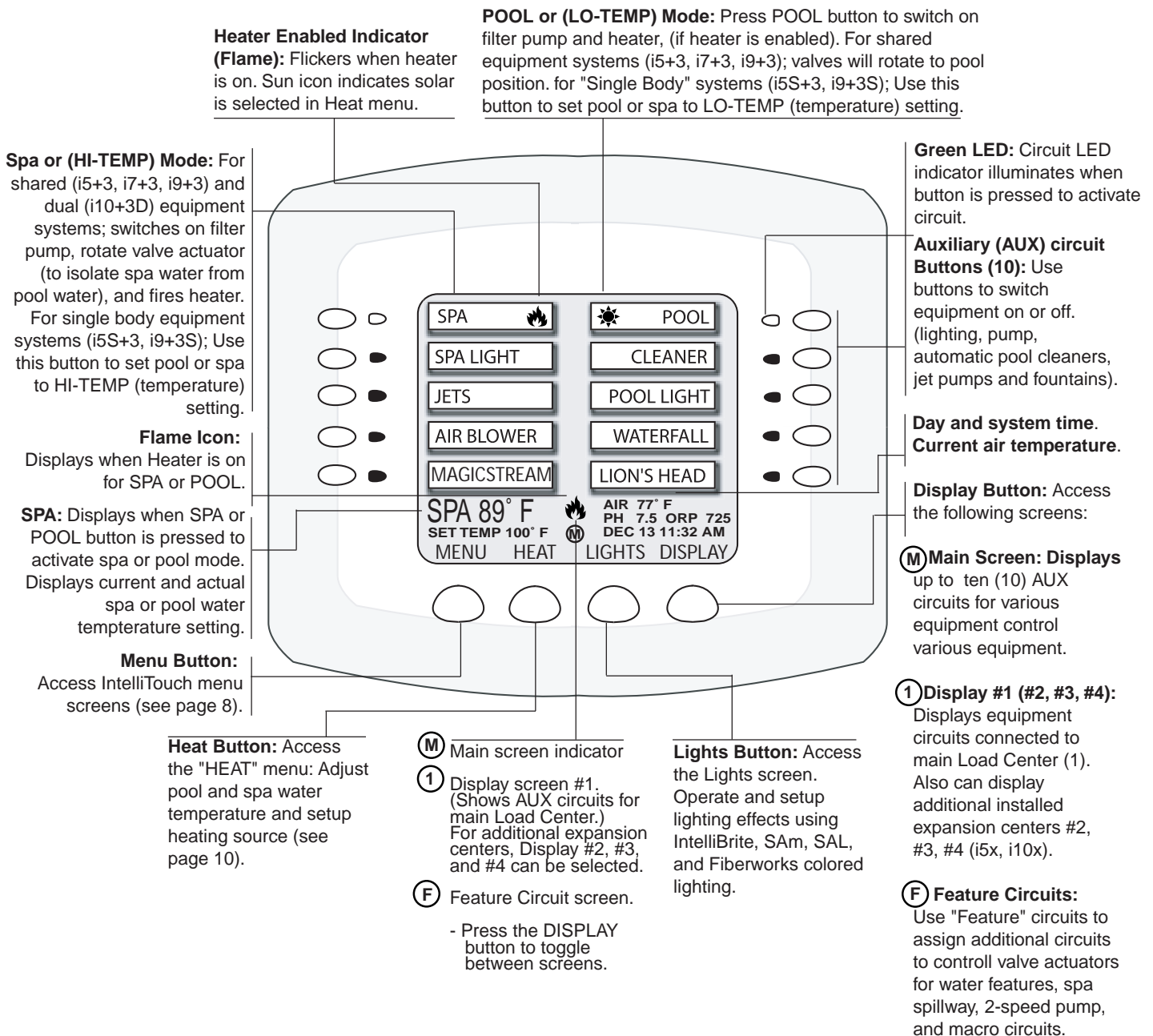

IntelliTouch Menu

The Indoor Control Panel menus provide system settings to automatically control the general day-to-day pool and spa operations. From the PROGRAM menus you can program equipment to switch on and off at specific times. From the SETUP and ADVANCED menus circuit functions, valves and other equipment can be setup.

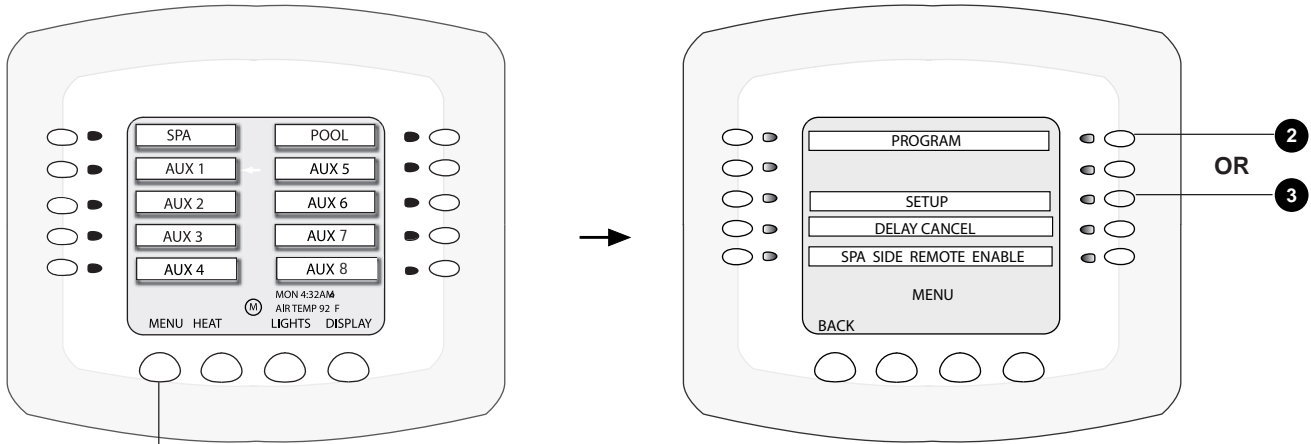

1 Press **MENU** button

Press **PROGRAM** or **SETUP** button

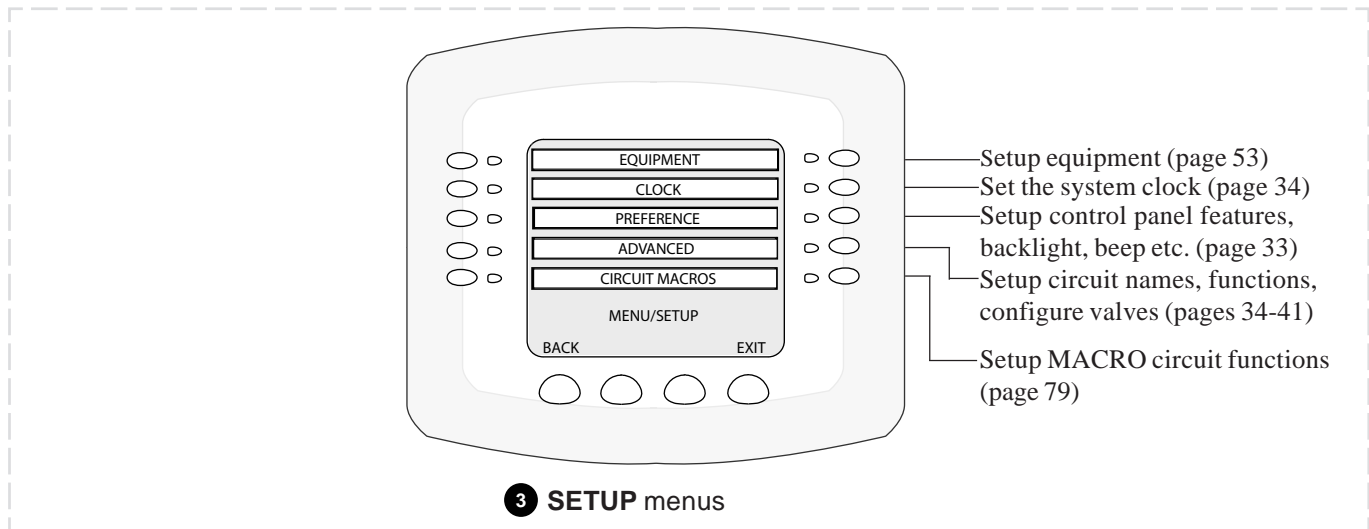
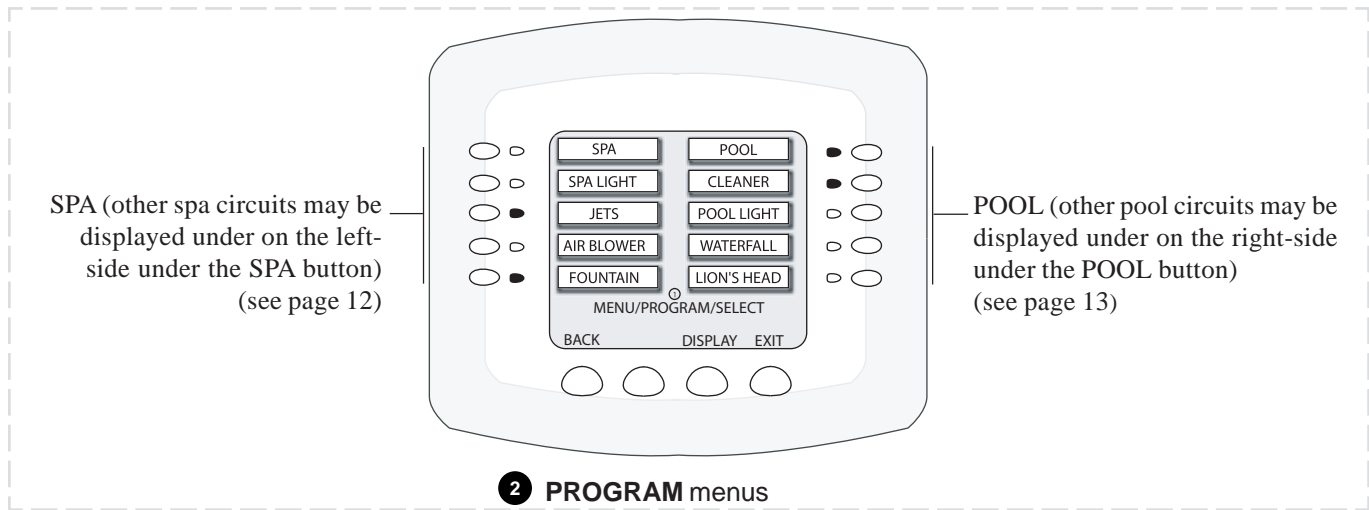

Indoor Control Panel Menus

INTELLITOUCH INDOOR CONTROL PANEL BUTTONS

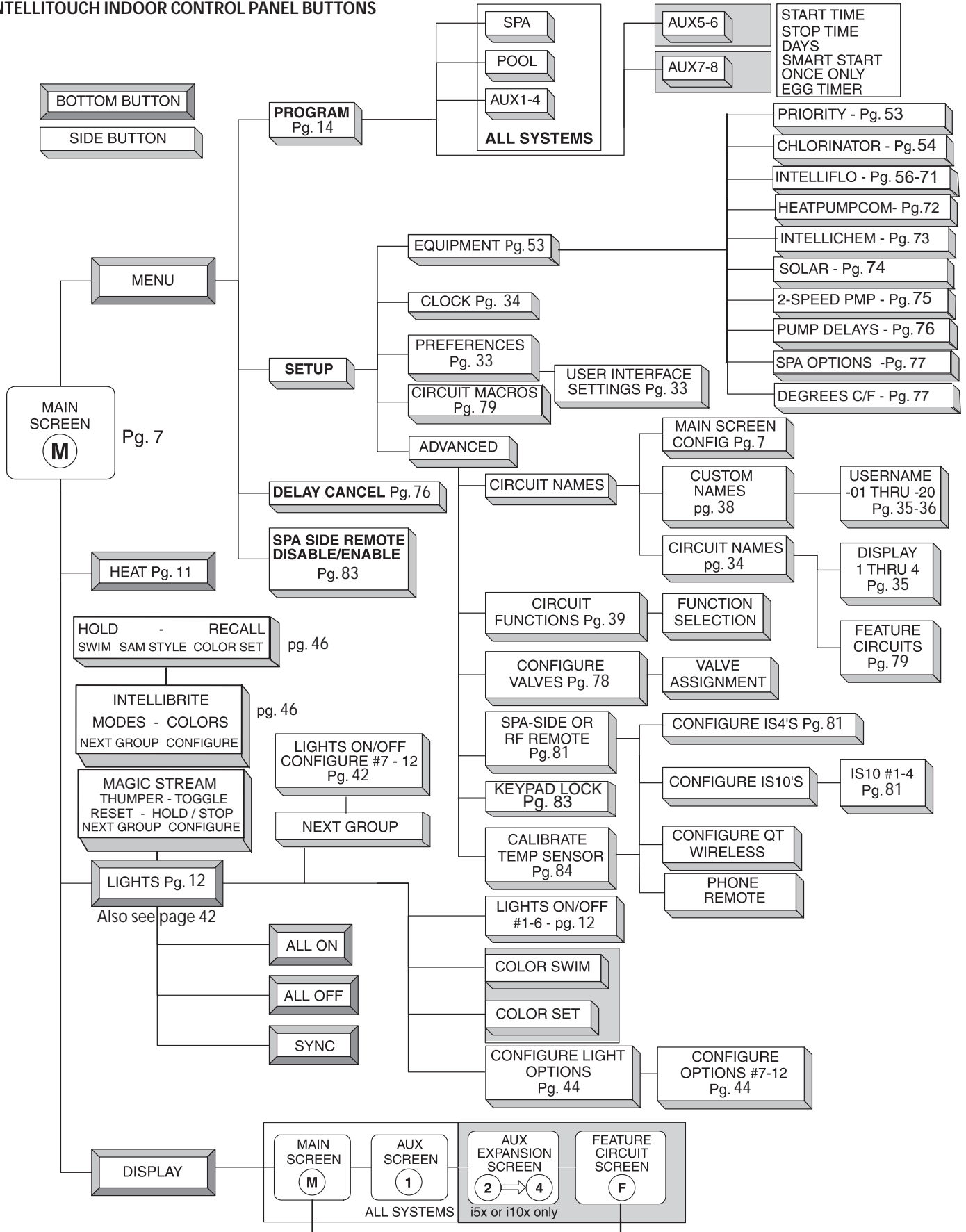

Heating your Spa and Pool

From the Heat screen, use **Spa** button (left side) or **Pool** button (right side) to adjust the heat temperature for your spa or pool. You can also switch the heater on or off from this screen. For single-body systems (models i5S+3 and i9+3S), spa and pool are replaced with **HI-TEMP** and **LO-TEMP** settings (for more information see page 7).

Adjust Spa or Pool Heat Settings

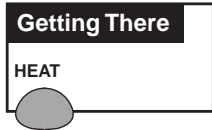

To adjust the spa or pool set point temperature, go to the **Heat** screen:

Note: Be sure the Spa Mode does not display “OFF.” If “OFF” is displayed, refer to “Configuring the Heating System Options,” page 11, for more information.

To adjust the spa or pool set point temperature, press the **HEAT** button at the bottom of the screen:

- **SPA:** Press the spa **Up** or **Down** buttons (top left and right side) to raise or lower the spa water temperature. The set point water temperature is displayed in the middle of the screen. The spa temperature setting can be adjusted from 40° F to 104° F or (4° C to 40° C).
 - **POOL:** Press the pool **Up** or **Down** buttons (third down from the top, left and right side) to raise or lower the pool temperature. The set point water temperature is displayed in the middle of the screen. The pool temperature setting can be adjusted from 40° F to 104° F or (4° C to 40° C).
1. Press the **Set** button to save the set point temperature settings. The current spa and pool water temperatures are displayed on the main screen (see page 7).
 2. Press the **Back** button to return to the Main screen.

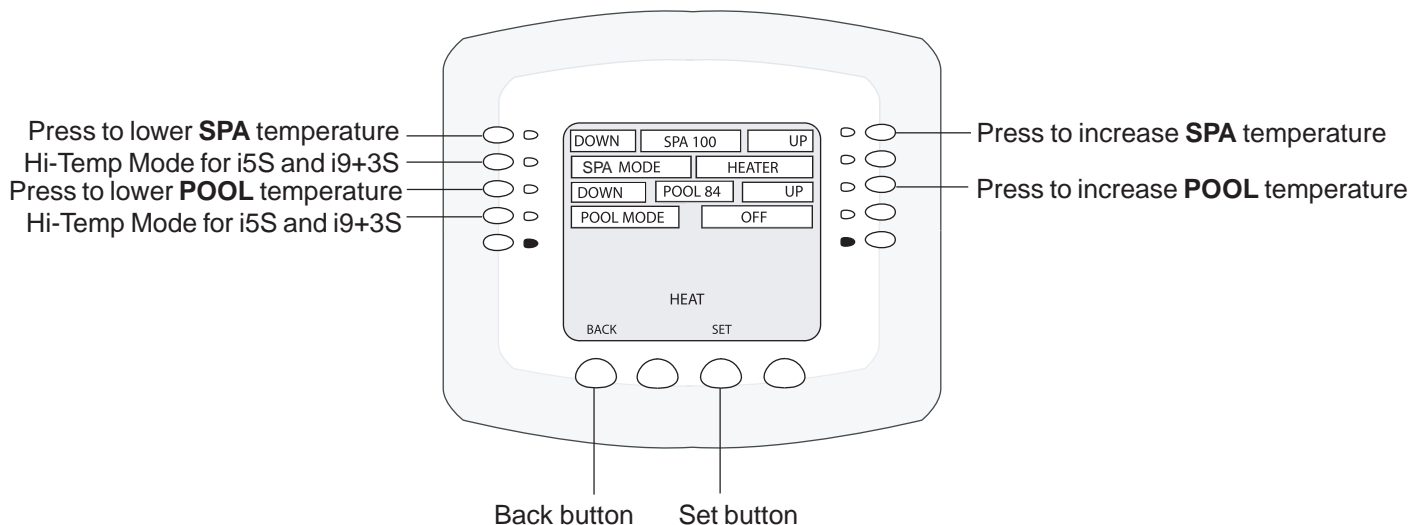

Selecting the Heating System

Use the heat menu settings to specify the set point temperature and select the heat source to heat the pool and spa water. The water will begin to heat when the heater is manually switched on, by pressing the Pool, Spa button on the Indoor Control Panel or the Valves (V) button on the Outdoor Control Panel, regardless of the heater selection (off) in the Heat menu. The optional iS10 Spa-Side remote, iS4 Spa Side remote or QuickTouch QT4 wireless remote can be used to switch the heater on. The IntelliTouch system supports gas, electric and solar heating systems. IntelliTouch will use the heating source that is selected. Multiple heaters are supported. IntelliTouch automatically selects the heating system that is most effective for the user settings. The heat source selections are:

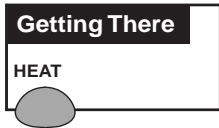

To select the heating system, press the **HEAT** button at the bottom of the screen.

- **SPA:** Press the left or right side button next to SPA MODE to select the heating mode for the spa.
 - **POOL:** Press the left or right side button next to POOL MODE to select the heating mode for the spa.
1. Press the **Set** button to save the heat settings.
 2. Press the **Back** button to return to the Main screen.

The heat options are:

- **OFF** - No heating even though pump and other circuits may be operating.
- **HEATER** - Gas heater only. When the heater is active it will continue heating the water until the heater's current highest set point temperature triggers the heater sensor (104° F or 40° C). Do not activate the heater without running the pump. The heater will not run if water flow is not detected.
- **HEAT PUMP** - Heat pump only.
- **H PUMPPREF.** - For when a heat pump is in combination with other heating systems and you want to use the heat pump only when it is most effective.

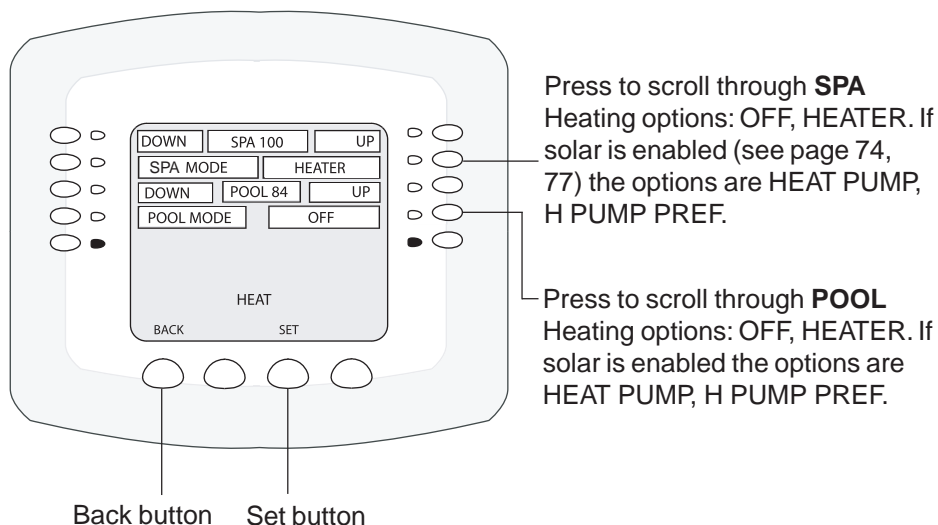

Switching on Lights Manually

Up to 12 individual lights (IntelliBrite® LED light, MagicStream® laminars, SAm® or SAL color lights) can be switched on or off from the Lights screen. There are two light screens which can display up to six light circuits. Use the “Next Group” button to access each group of six lights. You can also use the “ALL ON” or “ALL OFF” buttons to switch all lights on or off. The “SYNC” button will also switch on then sync all color changing lights to synchronize their colors when using the “Color Swim” feature. You can also configure IntelliBrite® lights, MagicStream laminar lights, and setup the *Color Swim*, and *Color Set* special lighting features from the Lights screen. Lights that have dimming functionality can be also dimmed from the Lights screen. *SAm*, *SAL*, fiber optic, Halogen lights, and IntelliBrite cannot be dimmed. For more information, refer to “Setting up Lighting Options,” page 42.

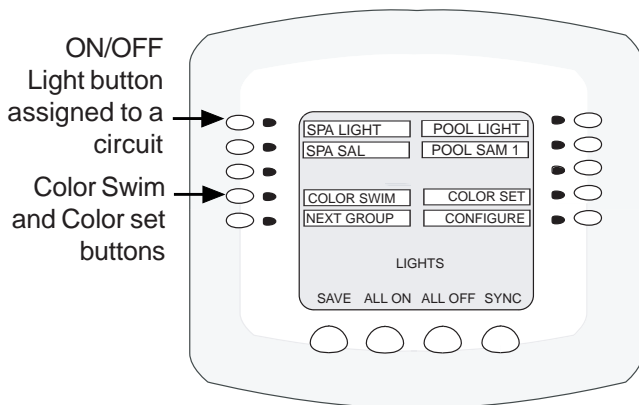

Lights screen (SAm/SAL Color Swim and Color Set)

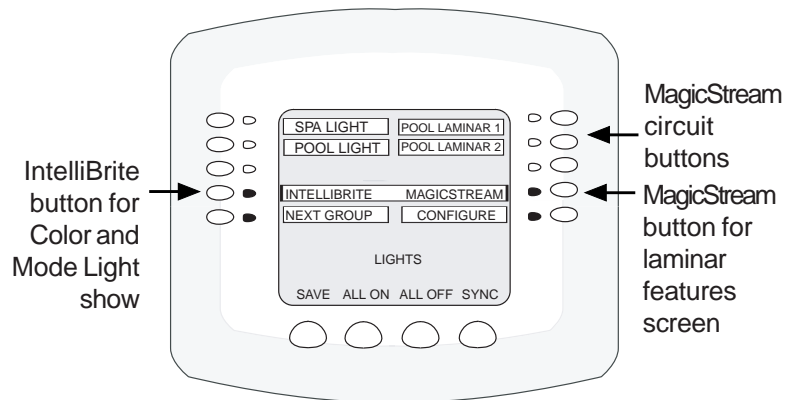

Lights screen with IntelliBrite lights and MagicStream laminars

To switch on lights, press the **Lights** button on the bottom of the Lights screen.

Getting There

LIGHTS

1. To switch a light on, press the button next to the name of the light. Up to six (6) light circuits can be displayed in the upper part of the Light screen.
2. If there are more than six (6) light circuits assigned, press the **NEXT GROUP** to see these circuits.

 - Press the **All ON** button at the bottom of the screen to switch all the lights on.
 - Press the **All OFF** button at the bottom of the screen to switch off the lights when you are done.

Note: Use the *SYNC* button to switch **ON** all IntelliBrite, MagicStream laminar lights, SAm, SAL, or FIBERworks® color changing lights to synchronize their colors when using the “Color Swim” lighting feature.

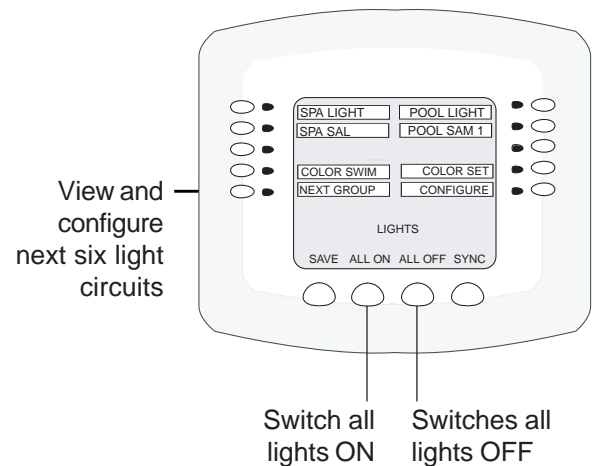

Special Lighting Features

At least two (2) IntelliBrite, *SAm* and/or *SAL*, and/or *FIBERworks* lighting systems are required to use the Color Swim, Color Set and Sync special lighting features. Up to twelve (12) lights can be independently controlled from the **Lights** screen.

SAm, *SAL*, or *FIBERworks* lighting special lighting features:

Note: *The IntelliBrite Color Swim and Color Set (SAm Style) feature is accessed from the Lights screen. See page 46 for more information.*

- **Color Swim** - Presets the light circuit to transition through colors in sequence. This gives the appearance of colors dancing through the water. You can adjust the delay of each light to make the colors move at different speeds. This feature requires a separate relay for each light.
- **Color Set** - Presets the light circuit to a specific colors. This feature requires a separate relay for each light.
- **Sync** - Switches on all IntelliBrite, *SAm*, *SAL*, or *FIBERworks* color changing lights to synchronize their colors.

Note: *For SAm and SAL lighting setup information, see “Setting up Lighting Options,” on page 42.*

To activate the special lighting features, press the **Lights** button on the bottom of the main screen.



Light buttons:

- Press the COLOR SWIM button to start the changing color lights feature.
- Press the COLOR SET button to set all lights to a pre-programmed color.
- Press the SYNC button to switch on all color changing lights to synchronize colors.
- To configure lights on this screen press the CONFIGURE button.

Note: *Depending on what kind of light is being activated and what mode it was in previously, it may take up to a minute or more after the Color Set, Color Swim, or Sync button is pressed to activate the feature.*

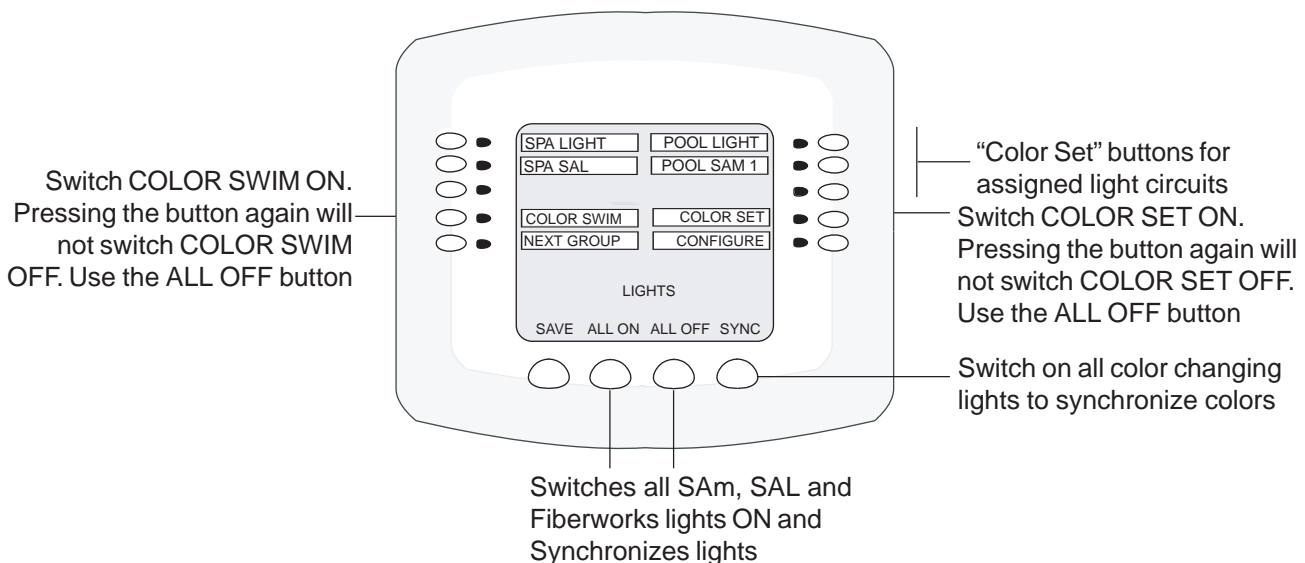

Dimming Lights

In order to dim lights, the Dimmer Module (P/N 520406) must be installed by a qualified electrician in the IntelliTouch Load Center or Power Center. Only incandescent tungsten filament lights can be dimmed (not Halogen lights). Lights that have dimming functionality can be dimmed from the Lights screen. *SAM* or *SAL* fiber optic lights, MagicStream Laminars, Halogen and IntelliBrite lights **cannot** be dimmed. For more information, refer to “Setting up Lighting Options,” page 42. The circuit must be assigned to the “Dimmer” circuit function (see page 41) in order to operate correctly.

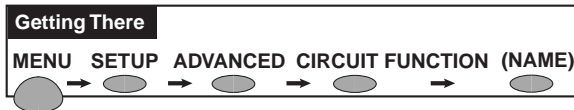

To dim lights, go to the assigned circuit name:

1. Press the button next to the circuit name. A light should come on and be switched on at the specified dimming level.
2. To change the dimming level, hold the circuit button down until the **Dimmer Level Settings** screen displays as shown.
3. Press the button next to **Decrease** to decrease the dimming level, and the button next to **Increase** to increase the dimming level. The percent value displays the current dimming level setting.
4. Press **Save** when done. The light will adjust to the set dimming level.

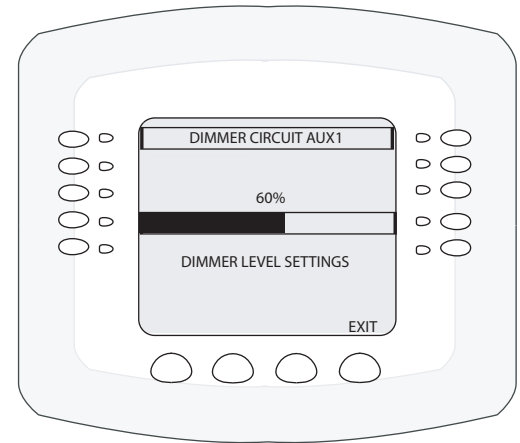

Note: Macros can turn on light dimming circuits, but lights cannot be dimmed through the macro. The dimming level must be changed for each light dimming circuit.

Setting ON/OFF Times for Equipment (PROGRAM)

You can create schedules to automatically run equipment like pool filtration or lights. Any circuit can be set to switch on and off on every day of the week. When a relay is switched on manually, it remains on until you either switch it off manually, or the next time the relay is scheduled to be switched off. For example, if the filter pump or any circuit is scheduled to run from 9AM to 4 PM and the programmed schedule is turned OFF at 1:00 PM and then turned on at 1:10 PM, the circuit will turn OFF at its programmed OFF time of 4:00 PM. But if the circuit is turned on after 4:00 PM, the factory set Egg Timer of 12 hours is now engaged. So if the circuit was turned on at 6:00 PM that circuit will turn off at 6:00 AM (12 hours later). If the circuit was turned ON at 5:00 PM and because a programmed OFF time had been set to turn off at 4:00 PM, the circuit would operate for 11 hours. A spa or pool program can be overridden using the Spa or Pool button to switch the circuit on.

From the “Program” screen, you can schedule IntelliTouch to automatically run equipment like pool filtration or lights. Any circuit (auxiliary, feature, or macro) can be scheduled to switch on and off at a specific time and on a any day(s) of the week. Up to 99 total programs may be created for all circuits combined.

Schedule a program: The “Program” screen displays a program counter in the upper right (1/0) side of the screen. This counter indicates the current number of scheduled programs. After setting the start and stop time and the day(s) to run the first scheduled program, press **Save** to view the first program (1/1) and increment the counter to next program. To access the next program screen, press the button next to the counter label (2/1). Set the start and stop time and the day(s) to run the second scheduled program (2/1). Repeat this process to enter another program. For example, **2/3** indicates that you are viewing **program 2 of 3** total programs saved for that circuit. **4/3** indicates that you are creating program 4 but only 3 are currently saved. After pressing the Save button, the counter updates to 4/4. Press the button to the right of the label counter to step through each program first then display the unsaved program screen. The following describes how to program equipment to run the pool filtration system. This process is the same for any installed equipment listed on the screen.

Go to the **PROGRAM/SELECT** equipment screen. From this screen you can select SPA, POOL or any of the AUX equipment circuits to program.

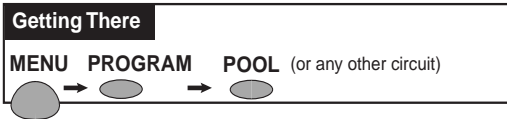

1. Press the top right button next to **POOL** to access the “Program” screen to program the pool equipment.
2. **To set the start time:** Press the left side button next to **HOURS** (and the start flag icon) to set the start hour. Press the right side button to set the minutes for the start time. To use the “EGGTIMER” feature, see page 17.
3. **To set the stop time:** Press the left side button to **HOURS** (and the stop icon) to set the hour to stop the program. Press the right side button to set the minutes for the stop time. To use the “ONCE ONLY” feature, see page 16.
4. Press the left side button next to **DAYS** to specify the day(s) to run the program one time. Choose “**EVERYDAY**” to run the program one time each day of the five days. To choose specific days to run the program, press the button next to **DAYS**. The days of the week screen displays. The LED lights next to the days of the week will all be lit. To switch off a day, press the button next to the displayed day. The light switches is off. To set all day on, all lights should be on. Press **Save** to save the setting. The previous screen will be displayed.
5. Press **Save** to save the current program. The program counter displays (1/1) indicating that you have saved one (1) program for the selected circuit. To erase a program press the **Clear** button then **Save**.
6. Press the **Back** button to return to the **SPA, POOL** and **AUX** equipment selection screen to choose other equipment. Press the **Exit** button to return to the main screen.

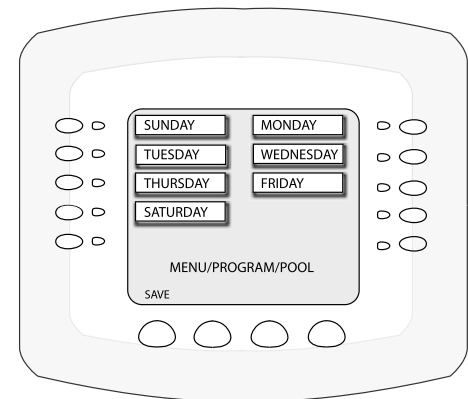
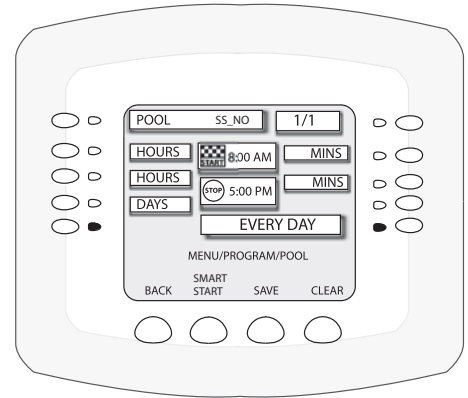

Smart Start (Setting up SAM, SAL and IntelliBrite lights)

Smart Start (SS_Yes/SS_No) - When a light circuit function is setup as a SAM, SAL or IntelliBrite light, use the Smart Start feature (SS_Yes) to automatically begin changing colors when the light circuit is switch on. Smart Start can also be assigned to all other special light circuits (i.e. Color Wheel, Photon Generator®, Light, see page 41).

1. Press the top right button next to **SAMLIGHT** to program the light circuit. For this example the SAL LIGHT circuit name has already been selected from the Circuit Names list (see page 37).
2. **SS_Yes/SS_No** displays next to the light circuit name.
3. **Smart Start** displays at the bottom of the screen. Press the button on the bottom of the screen to toggle between SS_Yes and SS_No. Select **SS_Yes** to automatically begin changing colors when the light circuit is switch on.
4. Setup each light circuit as described above in steps 2 - 5.

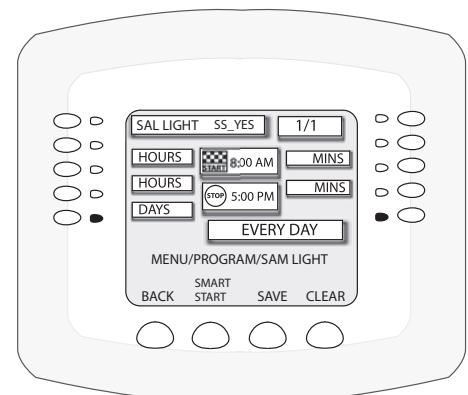

Using the Once Only Timer

The “Once Only” programming feature enables IntelliTouch to automatically switch equipment on for one time only. For example, you can set to have the spa and heater switch on before you get home from work for one evening. Unlike a regular scheduled program, the “Once Only” program does not repeat.

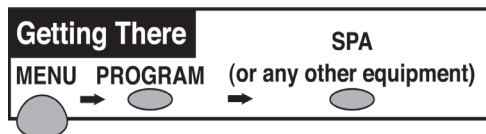

Go to the **PROGRAM/SELECT** equipment screen. From this screen you can select SPA, POOL or any of the AUX equipment circuits to program.

The following example describes how to program the spa filter pump and heater to switch on at a specific time:

1. Press the button next to **SPA** to access the “Program/Select” screen. If this is the first program, the program counter displays (1/0). After this program is saved, (1/1) is displayed (see step 5). Up to 99 total programs may be created for all circuits combined.
2. Press the left side button next to **HOURS** and select **ONCE ONLY** (Once Only is displayed one press after 11:00 PM).
3. Press the left side button next to **HOURS** to set the start time.

Note: Press the button under CLEAR to reset the default settings.

4. Press the left side button next to **DAYS** to specify the day(s) to run the program one time. Choose **EVERYDAY*** to run the program one time each day of the five days. If the time you are setting has passed for today, the **ONCE ONLY** program is set for the next day. To choose specific days to run the program, press the button next to **DAYS**. The days of the week screen displays. The LED lights next to the days of the week will all be lit. To switch off a day, press the button next to the displayed day. The light switches off. To set all days on, all lights should be on.

Note (): If you select EVERYDAY, the programmed time will occur the next day or later the same day if the time has not yet been reached. If you select a certain day of the week (only one) the programmed time will happen the next day of the week.*

5. Press **Save** to save the current program. The program counter displays (1/1) indicating that you have saved one (1) program for the selected circuit.
6. Press the **Back** button to return to the **SPA, POOL** and **AUX** equipment selection screen to choose other equipment.
7. Press the **Exit** button to return to the main screen.

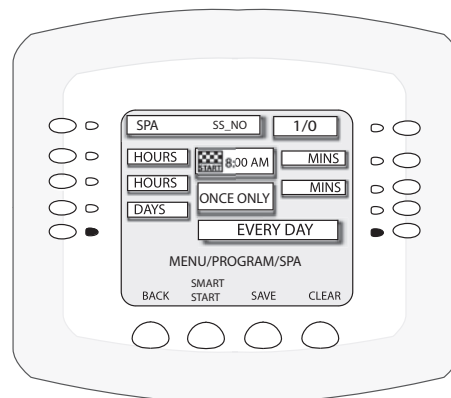
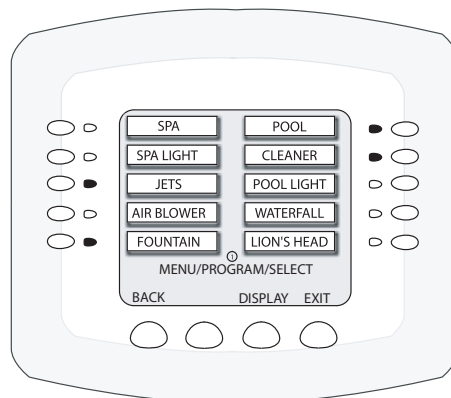

Setting the Egg Timer Function

The “Egg Timer” feature lets you manually switch on equipment and switch off automatically after a specified time. You can set this timer feature for other equipment such as lighting, the spa, or the spa jets. Equipment can be programmed to be switched on for one minute to 24 hours. You can also use the “Don’t Stop” feature to override the 12 hour default switch off time, and run continuously until manually switched off.. If you have never set the timer for a specific piece of equipment, the factory default time is set to 12 hours.

If you have a power outage, this feature will not switch the equipment back on, you need to use set the system in “Service” mode at the outdoor control panel center to switch the equipment back on. For more information, refer to “Using the Service Personnel Screen” on page 85.

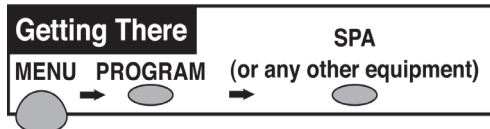

Go to the **PROGRAM/SELECT** equipment screen. From this screen you can select SPA, POOL or any of the AUX equipment circuits to program.

The following example describes how to program the spa equipment using the “Egg Timer” feature:

1. To program the spa filter pump and heater to switch on and off at a specific time, press the button next to **SPA** to access the “Program/Select” screen. If this is the first program, the program counter displays (1/0). After this program is saved, (1/1) is displayed (see step 6). Up to 99 total programs may be created for all circuits combined.
2. Press the left side button next to **HOURS** until **EGG TIMER** is displayed. (EGG TIMER is displayed one press after 11:00 PM).
3. Press the left side button next to **HOURS** (under **EGG TIMER**) to set the count down run time in hours (from 00:00 to 23:00 hours). You can also select “**DON’T STOP**” to run the circuit continuously until switched off manually. “**DON’T STOP**” is displayed one press after 23:00.
4. Press the right side button next to **MINS** to set the run time minutes.

Note: Press the button under **CLEAR** to reset the default settings.

5. For the “Egg Timer” feature **ALWAYS** is displayed, indicating the program will run and automatically shut-off in the specified time.
6. Press **Save** to save the current program. The program counter displays (1/1) indicating that you have saved one (1) program for the selected circuit.
7. Press the **Back** button to return to the **SPA, POOL** and **AUX** equipment selection screen to program other equipment.
8. Press the **Exit** button to return to the main screen.

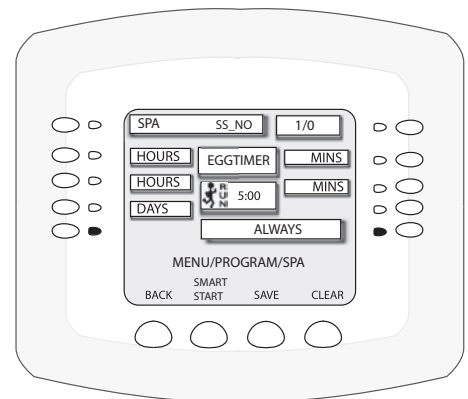
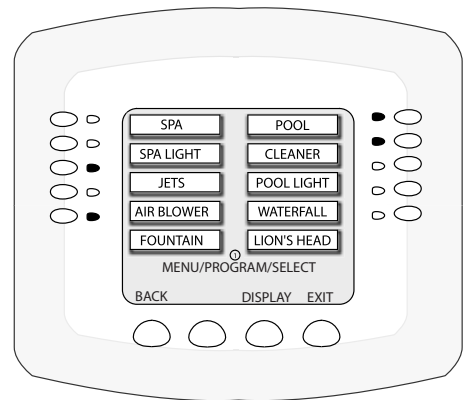

SpaCommand Ten Button Spa-Side Remote

The SpaCommand spa side remote controller can control up to ten functions including a spa temperature adjustment. As many as four SpaCommand remotes can be installed in i5+3, i5S+3, i7+3, i9+3, i9+3S, and i10+3D systems. The remote controller is for use with the IntelliTouch systems at the water’s edge. Five (5) in-line buttons control up to ten (10) system functions numbered one through five from left to right as shown (if the system allows). A label above or below the buttons identifies each circuit function. A red status LED above and below the toggle button indicates which row (Top or Bottom) is active. When one of the in-line buttons is pressed, an adjacent red status LED will be on light, indicating that the circuit has been activated. The default circuits activated by each button are shown in the table below. The remote includes an LED display shows the current spa water temperature. The spa temperature may be increased or decreased by pressing the up or down arrow button located under the display. The temperature display will blink while being changed. After setting the desired temperature, the display will return to steady and show the actual temperature as it meets the set point. The temperature set by the remote is only temporary. Any two buttons can be assigned to increase or decrease the IntelliFlo VF or VS pump’s flow (GPM) rate or speed (RPM). Each press of the button increases or decreases the pump’s flow rate or speed (see page 81) until the GPM or RPM is reached as specified in the IntelliFlo menu. When the Spa mode is switched OFF, the temperature set at the Indoor Control Panel will resume the next time the spa mode is activated (see “Spa Manual Heat” on page 77). The Spa Mode will automatically turn off after 24 hours. For iS10 setup and configuration information, see page 30 and 81.

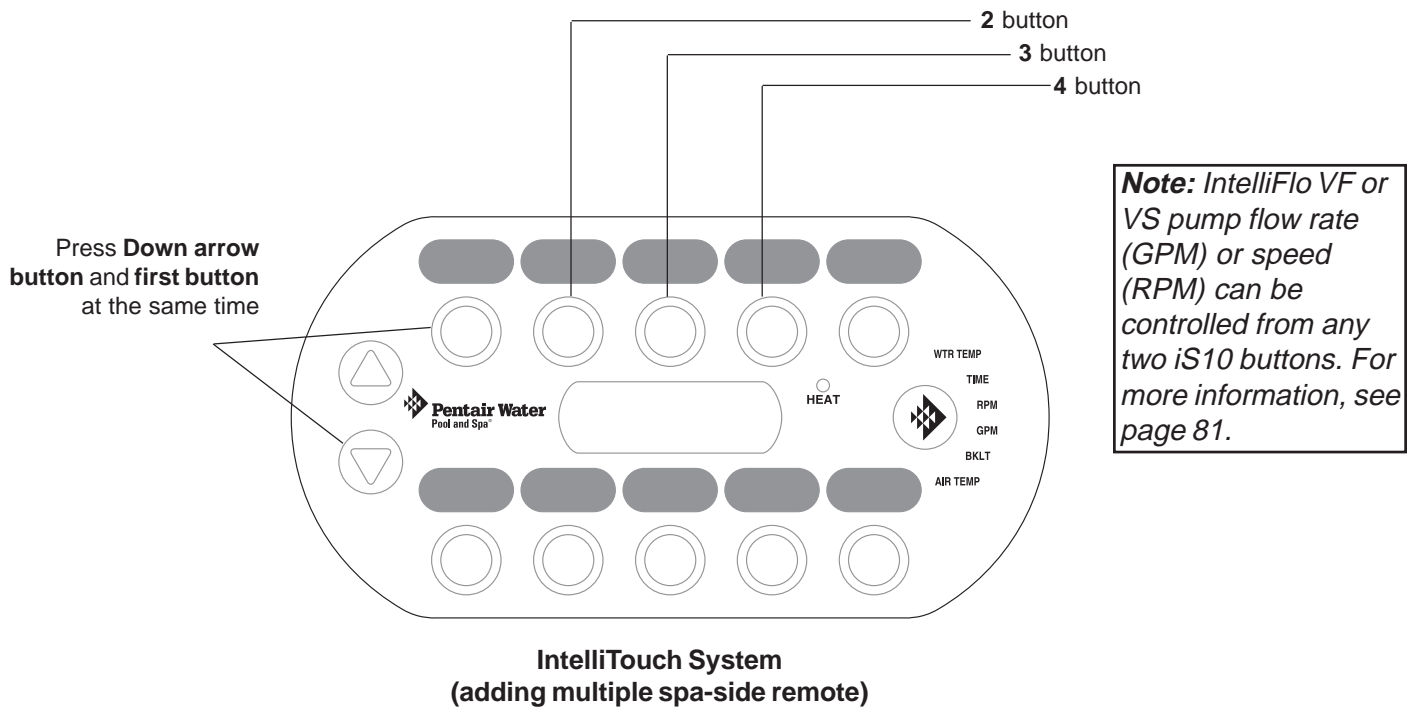

iS10 Spa-Side Remote Controller

Button 1	i5+3, i7+3, i9+3, -10+3D,	SPA	POOL
	i5S, i9+3S	Top Row HI-TEMP	Bottom Row LO-TEMP
Button	2	AUX 1	AUX 5
Button	3	AUX 2	AUX 6
Button	4	AUX 3	AUX 7
Button	5	AUX 4	AUX 8

iS4 Spa-Side Remote Controller

The iS4 Spa-Side remote controller is a double-insulated, waterproof device that is UL (1563) listed for installation at the water's edge. The iS4 is typically installed at the tile-line of the spa wall, or in the deck within arm's reach of a spa occupant. The iS4 provides remote switching of up to four control circuits from the spa or nearby location. Use the iS4 for switching on the spa pump and heater or other auxiliary equipment (i.e., lights, jet pump, air blower, etc.). The red LED status light glows steady when in spa mode and flashes while the spa is heating. For iS4 button assignment information, see page 81.

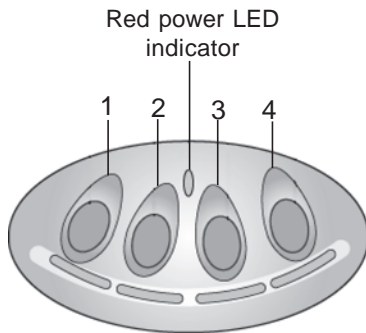

iS4 Spa-Side Remote Controller
(Wall or tile mount)

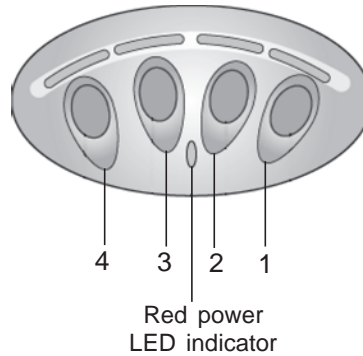

iS4 Spa-Side Remote Controller (Deck mount)

Note: IntelliFlo VF or VS pump flow rate (GPM) or speed (RPM) can be controlled from any two iS4 buttons. For more information, see page 81.

MobileTouch Wireless Controller

The MobileTouch wireless controller provides the same functionality as the IntelliTouch Indoor Control Panel. It has an operating range of up to 300 ft. from the MobileTouch transceiver antenna (line of sight) which is typically located near the IntelliTouch load center. The optimum wireless transmit and receive range may be affected by physical obstructions, (especially those containing metal), weather conditions, and geographical features.

The MobileTouch controller screen is an LCD (liquid crystal display) which can be sensitive to sunlight. When exposed for extended periods the LCD screen will heat up and go black. If this happens, place the remote in a shaded area and allow the screen to cool down. Do not attempt to adjust the contrast or the screen will be unreadable when it eventually cools. When used outside, keep the remote covered or in a shaded area. Prolonged exposure to sunlight may permanently damage the unit.

⚠ WARNING! Do not plug in the AC adapter to a power source within five (5) feet of the pool and spa. Canadian installations require a minimum of (3) meters from pool water. Do not recharge outdoors. Only use Pentair Water Pool and Spa® approved AC adapter transformer.

The MobileTouch wireless controller is water resistant and can be exposed to temporary splashing or wet hands. However, the controller is not intended to be submersed. Remove unit immediately if it is dropped in the water or exposed to rain. Store the unit indoors in a dry environment. Be sure the gold charging contacts are dry before charging.



MobileTouch Wireless Controller

MobileTouch Wireless Controller (Previous Model)

The previous model of the MobileTouch wireless controller and Transceiver antenna cannot be used with the latest model of the MobileTouch wireless controller and Transceiver antenna. Both models cannot coexist in the same IntelliTouch system.

Charging the MobileTouch Wireless Controller

When you are not using the MobileTouch controller, place it in the cradle to recharge the battery. This allows the battery to be fully charged at all times.

To charge the MobileTouch controller battery:

- Plug the AC adapter into an AC wall outlet. Insert the AC Adapter plug into the bottom of the cradle and place the MobileTouch controller in the cradle. **Note:** *When the MobileTouch controller is placed in the cradle the display and backlight will be on. After five minutes the backlight will shut off. The MobileTouch controller and display are always on when seated in the cradle. To turn the backlight on, press any button.*

Charging the battery:

- If the battery screen icon displays one or no bars or the screen is blank, this may indicate that the battery cannot power the device and needs recharging. During battery recharge, the battery icon bars scroll from right to left. A complete battery charge takes about 3 to 4 hours. After a complete battery recharge, the battery icon is replaced with a **power plug** icon, indicating the battery is fully charged and is now operating on AC power from the cradle. **Note:** *If the battery requires replacement, only use Pentair Water Pool and Spa® replacement battery (P/N 520815Z).*

Using the MobileTouch Wireless Controller

The range of the MobileTouch wireless controller can be up to 300 feet from its transceiver antenna (line of sight). The transceiver antenna is typically located outside near the IntelliTouch Load Center. The device can be used all day at full power with a complete battery charge (3 to 4 hours).

To use the MobileTouch wireless controller:

1. Remove the MobileTouch wireless controller from the cradle. The controller can also be used while seated in the cradle with AC power connected to the cradle.
2. Press the Power button on the front right-side to switch the unit ON. The main screen is displayed. The LCD backlight will turn off in five minutes if not in use. The battery icon displays three bars, indicating the battery is fully charged. Press the controller's power switch to switch Off the device.

Note: *For details about enabling the MobileTouch wireless controller, refer to "Setting up the MobileTouch Wireless Controller," page 28.*

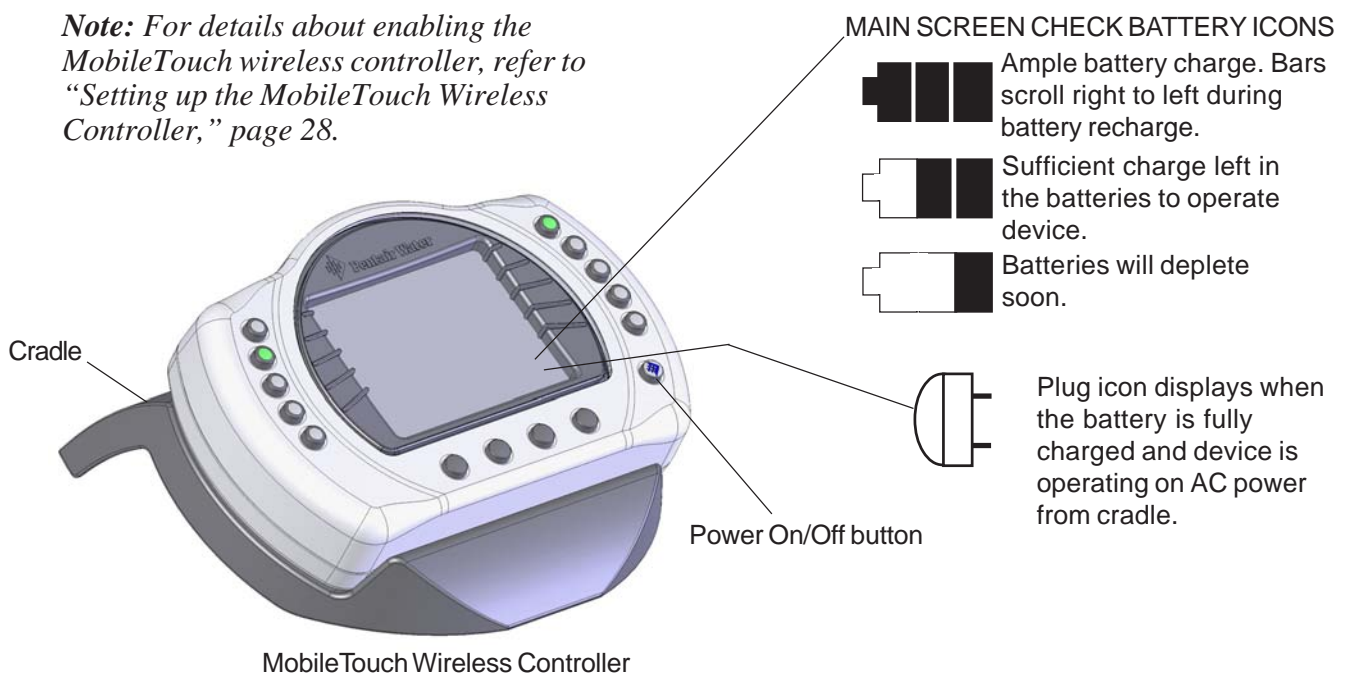

QuickTouch Wireless QT4 Remote Controller

The QuickTouch QT4 wireless remote controller provides switching of up to four circuits. It is typically used for activating the spa circulation, and for operating three auxiliary pieces of equipment (such as lights, jet pump, air blower, waterfall, etc.).

Each of the four functions on the QT4 remote controller has an ON and an OFF button. To switch a circuit on or off, press and hold the appropriate button for at least a full second. For information about setting up the QT4 remote, see “Configuring Remote Control Button Circuits (iS4, iS10, QT4 QuickTouch, and Phone Remote), on page 81.

You can assign a circuit to any one of the four buttons. The factory default setup is::

- **SPA** button activates the spa circuit.
- **A** button activates **Auxiliary 1** circuit.
- **B** button activates **Auxiliary 2** circuit.
- **C** button activates **Auxiliary 3** circuit.

Note: To control circuits other than Spa, AUX 1, AUX 2 and AUX 3, it is possible to make adjustments through the Indoor Control Panel or MobileTouch wireless control panel.

IMPORTANT: The QT4 remote may be used with wet hands, but should never be submersed in water, as this could damage the unit. If accidental submersion occurs, dry unit out by removing battery cover and removing battery. Position unit so that water can drain out. Replace the battery cover when the unit is completely dry.



QuickTouch QT4
Wireless Remote
Controller

IntelliChlor® Salt Chlorine Generator (Accessory)

The IntelliChlor salt chlorinator uses a process known as electrolysis to produce Sodium Hypochlorite (liquid chlorine) from a low concentration of salt added to the pool water. Hypochlorite kills bacteria, oxidizes organic material, and kills algae, then reverts back to salt. IntelliChlor then reuses the salt and the process starts over again. The IntelliChlor system is comprised of the Power Center and Electrolytic Cell. The IntelliChlor Electronic Chlorine Generator system consists of one or more of the following:



IntelliChlor with Power Center

Power Center (P/N 520556): Provides power and controls communication to and from the IntelliChlor cell.

IC 20 Cell (P/N 520554): Designed for pools up to 20,000 U.S. gallons (75,000 liters). The cell will produce the equivalent of 0.70 pounds of pure chlorine per 24 hours of continuous pool pump run time. The IC20 cell uses two terminal blades and five bi-polar blades.

IC 40 Cell (P/N 520555): Designed for pools up to 40,000 U.S. gallons (150,000 liters). The cell will produce the equivalent of 1.40 pounds of pure chlorine per 24 hours of continuous pool pump run time. The cell uses three terminal blades and ten bi-polar blades.

IC 60 Cell (P/N 521105): Designed for pools up to 60,000 U.S. gallons (227,124 liters). The cell will produce the equivalent of 2 lbs. of pure chlorine per 24 hours of continuous pool pump run time. The IC60 cell uses a total of 15 blades (three terminal and twelve bi-polar blades).

IntelliChlor “dummy” bypass cell (P/N 520588): Recommended for new pool start-up.

Note: For IntelliChlor setup information, see “Chlorine Generator,” on page 54.

IntelliFlo® VF 3050 Variable Flow Pump (Accessory)

The IntelliFlo VF 3050 pump control system offers pool and spa filter automation and advanced features that include energy conservation and programmable scheduled water features for your pool, spa, cleaner, waterfall, and other applications.

The IntelliFlo VF 3050 pump can adapt to any application up to 130 gallons per minute, you simply program IntelliFlo to suit the application. IntelliFlo then dials in the perfect operating conditions.

IntelliFlo VF 3050 can reduce energy cost by as much as 90% based on a pool size up to 15,000 gallons, one turn per day with a 24 hour cycle.

IntelliFlo VF 3050 constantly monitors water flow and electrical current to ensure that the filtration system is operating at peak efficiency. This can result in maximum energy efficiency savings never before possible – up to 90% over conventional pumps. The system protects against loss of prime or impedance of flow, under and over voltage situations, and thermal overload or freezing.

With IntelliFlo VF 3050 there is no need for pump curves and hydraulic calculations to determine the right pump for the job. Just set the program for your pool size and desired turnover, and IntelliFlo VF does the rest.

Note: For IntelliFlo VF setup information, see page 56.

IntelliFlo® VS 3050 Variable Speed Pump (Accessory)

The IntelliFlo VS 3050 variable speed pump is well suited for pool, spa, cleaner, waterfall and other water applications. IntelliFlo VS 3050 operates at a maximum system flow of 160 gallons per minute (GPM). Using the IntelliFlo's control panel the pump can operate with one of the four selectable preset speeds or the adjusted speeds. IntelliFlo out performs all conventional pumps in its class. Advanced energy conservation features ensure that your filtration system is operating at peak efficiency.

The IntelliFlo 3050 variable speed pump can operate from 400 RPM to 3450 RPM with preset speeds of 750, 1500, 2350, and 3110 RPM. The pump can be adjusted from the control panel to run at any speed between 400 RPM to 3450 RPM for different applications. The IntelliFlo pump control panel alarm LED warns the user against under and over voltage, high temperature, over current and freeze protection.

Note: For IntelliFlo VS 3050 setup information, see page 56.

IntelliFlo® VS+SVRS and VSF+SVRS Pump (Accessory)

The IntelliFlo VSF+SVRS variable speed and frequency (RPM/GPM) pump offers the same basic feature set as the IntelliFlo VS 3050 pump with additional Safety Vacuum Release System (SVRS) and flow control (GPM) functionality.

Note: For IntelliFlo VSF+SVRS setup information, see page 65.



IntelliFlo pump

Preparing the System for Initial Start-up

Setting up the IntelliTouch System

Use the following recommended steps to configure the IntelliTouch system using the Indoor Control Panel or MobileTouch wireless controller.

1. Main screen preference settings (page 33)

Setup the Indoor Control Panel main screen. Set the system clock and what circuit names you wish to display on the main screen.

2. Assign circuit names (pages 34-37)

Assign circuit names for output auxiliary equipment.

3. Creating custom names for auxiliary circuits (page 38)

There are twenty (20) user-defined circuit names available for identifying unique equipment (see page 38).

4. Assign a circuit function to a circuit name (page 79)

From your worksheet **Programmable Settings** section, assign circuit functions to all circuits that are not marked **GENERIC**. Nothing needs to be done if the circuit is **GENERIC** (simple ON/OFF when the button is pushed). From the **Circuit Functions** screen, you can also assign special logic (IntelliBrite, MagicStream, SAM, Floor Cleaner etc.) to a circuit by selecting one of the circuit functions. See page 41 for the complete list of circuit functions.

5. Create and assign a feature circuit name (page 79)

Review the temporary circuit names from the worksheet (page 89), create and assign circuit names to the auxiliary (AUX) connections. On the **Assign Circuit Screen**, auxiliary circuit names are assigned through **Displays 1 through 4**. Displays 1 through 4 correspond to the main Load Center or Power Center (Display 1) to which they are wired. Display 2 through 4 may be additional Expansion Centers. Note the original names presented, **AUX 1** through **AUX 10**, correspond to the plug-in location of the relay on the Outdoor Control Panel in the main Load Center or Power Center. Feature circuits are assigned on the **Feature Circuit** screen. Select from the available list circuit names. For a complete list of circuit names see page 37. Up to 20 additional custom circuit names can may be custom created (see page 38). For **Macro** circuits see page 80.

6. Configure valve actuators controlled by AUX or feature circuit (page 78)

Assign which circuits will activate which valves (A and B or optional C, D, E). If more than one circuit must operate the same valve, then one Feature Circuit may be created and configured to activate the valve. Then create Feature Circuits for all other circuits and use the Macro function to activate the valve along with any relay connections.

7. Setting up additional equipment (pages 53)

Configure the IntelliTouch system what special equipment the system may have installed.

- Is there an IntelliFlo pump installed?
- Is there an UltraTemp heat pump installed?
- Is there an IntelliChlor salt chlorine generator installed?
- Is there an IntelliChem automatic chemical feeder installed?
- Is solar heating available? Is solar being used for a heat pump?
- What circuits will turn 2-Speed pumps to High Speed? Cool-down cycle for the heater
- Lets you set circuits that switch the filter pump to high speed - Do you want to delay turning off the filter pump for 10 minutes when the heater is turned off?
- Do you want the spa to heat whenever the Spa button is pressed?

8. Set up Solar Equipment, 2-speed pump, Set a heater cool-down cycle (page 74)

Set up additional equipment if required such as solar equipment. Set up the chlorine generator

Set up the Indoor Control Panel to operate with optional salt chlorine generators.

9. Configuring the heater system options (page 11)

Setup gas heater, heat pump or heat pump used in combination with other heating systems.

10. Create Macros and Feature Circuits (page 80)

After the main circuits are set up, you can now combine circuits (Auxiliaries and Features) to maximize the system capability. Feature circuits that are assigned as **Macros** may also have all the same Circuit Functions and Equipment capabilities as any other circuit.

11. Configure spa-side remote (iS4, SpaCommand, QT4, QTII) buttons (page 81)

Set which circuits will be operated by which button on each remote. Once you have checked all buttons operate properly, place labels on remote controls.

12. Set on/off times for circuit from the Program screen (pages 14-17)

Set times for automatic circuit activation. Each system may have up to 99 total programs. All user created programs are active all the time; so check that there are not conflicting automated times.

13. Set up lights from the Lights screen (pages 42-52)

From the lighting screen you can control the pool, spa and backyard lighting, such as the color IntelliBrite LED lights, synchronized color changing *SAm*, *SAL* lights, *FIBERworks* lights and MagicStream laminars.

Wired Controllers (Automatically Enabled)

When powered up for the first time, the IntelliTouch system will automatically enable one each of the following wired controllers:

- Outdoor Control Panel (located in the main Load Center or Power Center)
- Indoor Control Panel (wired to the Personality board in Load Center). *Note: Additional Indoor Control Panels must be manually assignment.*
- SpaCommand Spa-Side Remote (wired to the Personality board in Load Center). *Note: Additional SpaCommand remotes must be manually assigned, see page 30).*
- Expansion Center (includes Outdoor Control Panel, model i5x or i10x). *Note: Additional Expansion centers must be manually assigned, see page 26).*

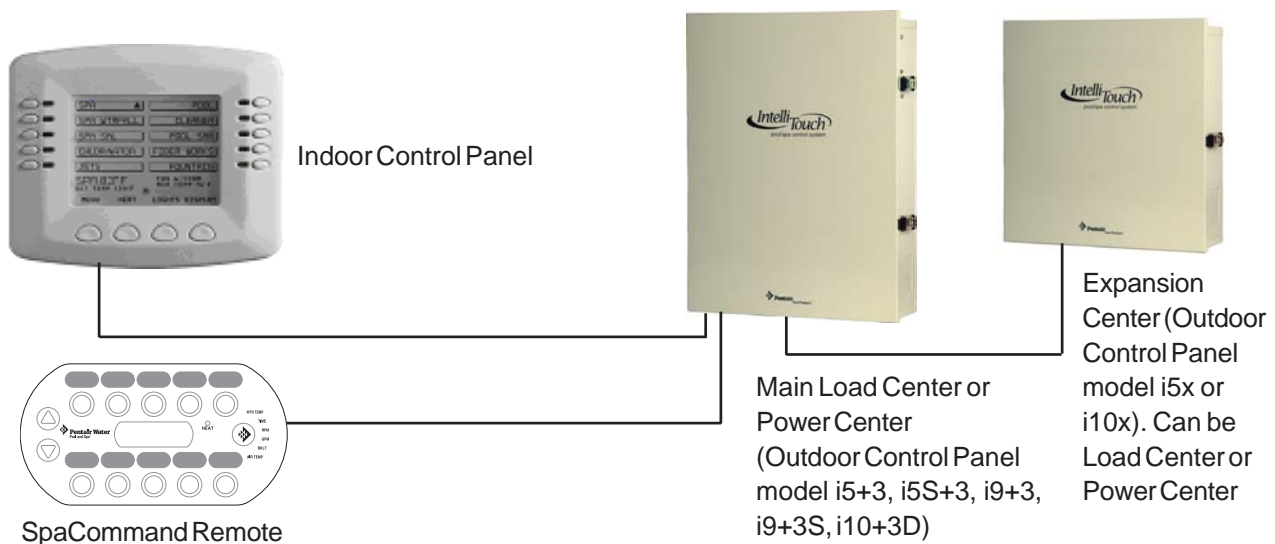

IntelliTouch System Controllers (automatically enabled)

Adding Multiple 10 button Spa-Side remotes and Expansion Centers

Additional SpaCommand spa-side remotes, and Expansion Centers need to manually enable from the Indoor Control Panel. To manually enable an additional Expansion Center, see page 26, and an SpaCommand remote, see page 30.

Adding a MobileTouch Wireless Controller

Before using a MobileTouch wireless controller with the IntelliTouch system, you must first manually enabled the wireless controller from the Outdoor Control Panel. For details, refer to “Setting up the MobileTouch Wireless Controller,” page 28.

Manually Enabling Expansion Centers

The following describes how to manually enable an additional Expansion Center containing the Outdoor Control Panel).

Note: For information about how the IntelliTouch automatically enables wired controllers, refer to the “Automatically Enabled Wired Controllers,” page 25.

Up to three (3) additional Expansion Centers can be installed in the IntelliTouch system. The IntelliTouch system automatically assigns the “main” Load Center or Power Center as number 1, and other additional Expansion Centers as number 2, 3, or 4. An Expansion Center (Load Center or Power Center) includes an Outdoor Control Panel (model i5x or i10x) which is connected to the main Load Center or Power Center.

Note: If the first Expansion Center was installed at the same time as the main Load Center or Power Center, it will automatically be assigned as number 2. Other additional Expansion Centers need to be manually assigned.

To manually enable additional Expansion Centers:

1. On the Outdoor Control Panel, press the **Reset** button.
2. The three (3) red **System Control** LEDs will be lit (solid). Wait a few seconds then press auxiliary **Button 1**. The three red **System Control** LEDs will begin flashing. The system is ready to enable additional Expansion Centers.

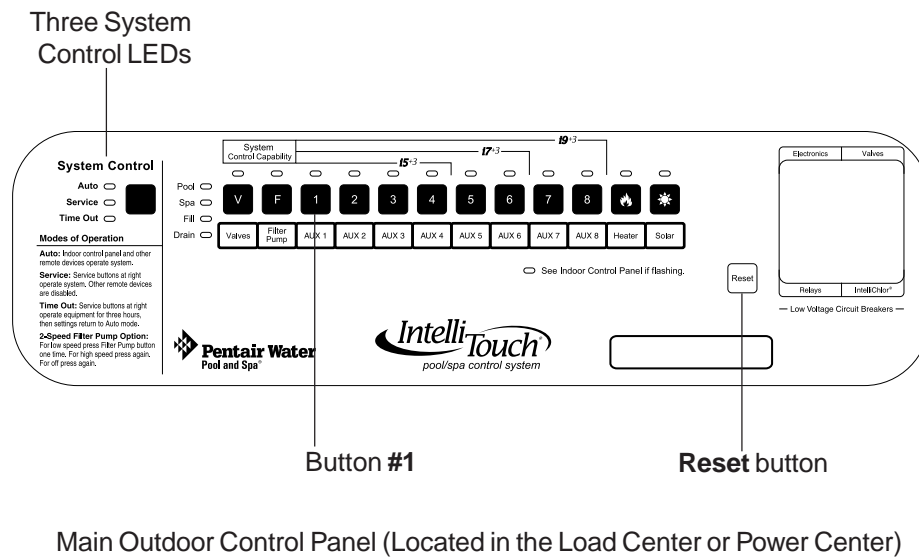

3. On the Expansion Center, press the **Reset** button and wait a few seconds, and press **Button 1**. The System Control LEDs on the Expansion Center will begin flashing.

Assigning Additional Expansion Centers

4. **Buttons 2, 3, and 4 LEDs** will be on. Do one of the following:

- If this is the first Expansion Center, press **Button 2**.
- If this is the second Expansion Center, press **Button 3**.
- If this is the third Expansion Center, press **Button 4**.

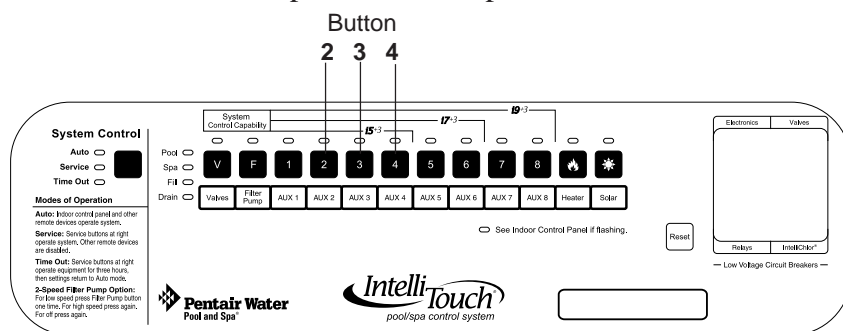

***Note:** For details about selecting the Indoor Control Panel display that are connected to additional Expansion Centers, see page 35.*

***Note:** Do not set more than one Expansion Center to the same number. These numbers correspond with the numbered display screens on the Indoor Control Panel and MobileTouch wireless controller.*

5. The red LED will be on above the selected button number.
6. Repeat the steps above for each additional Expansion Center.
7. After each Expansion Center is enabled, press **Reset** on the Outdoor Control Panel. Wait until the red Auto and Pool LED is lit. The system is ready for normal operation.

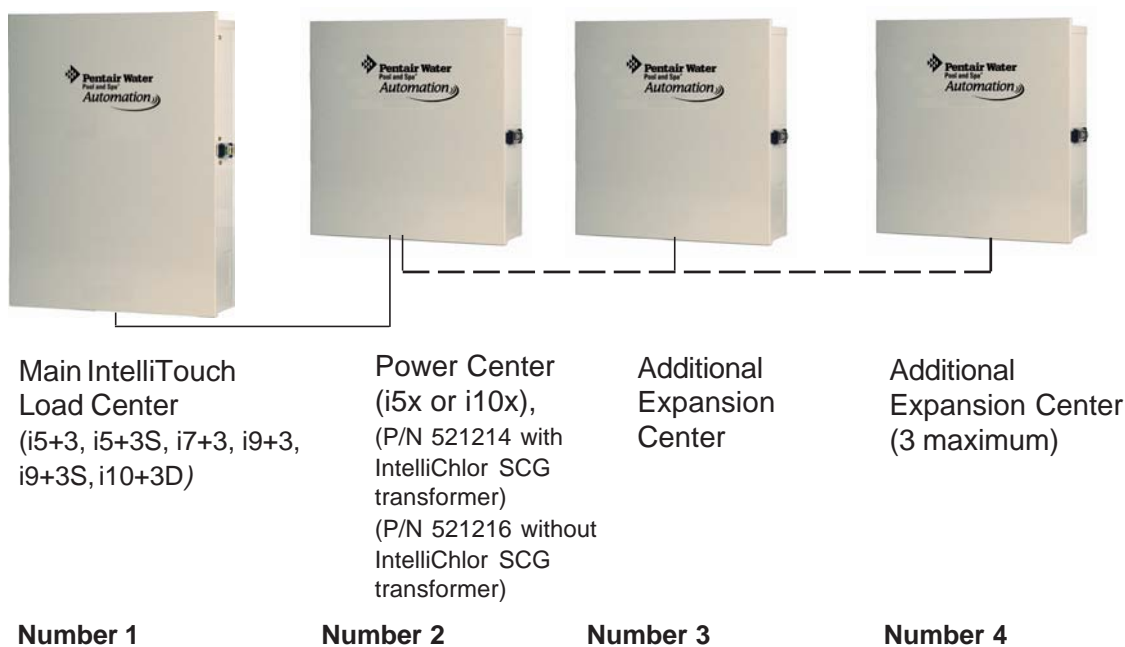

***Note:** Expansion Centers may be a Load Center or Power Center. Connections from the Main Load Center to an Expansion Center is via the COM port on the Personality board.*

Setting up the MobileTouch Wireless Controller

The following describes how to assign the MobileTouch wireless controller a communication address for the first time and to add a MobileTouch controller to a system with a controller already installed.

To manually setup a MobileTouch wireless controller:

1. On the Outdoor Control Panel, press the **Reset** button.
2. **First Time MobileTouch install:** The three red **System Control** LEDs will be lit (solid). Wait a few seconds then press the **“F” Filter** button. For model i10+3 press the **“P” Pool Filter Pump** button.

Add a MobileTouch with existing MobileTouch installed: The three red **System Control** LEDs will be lit (solid). Wait a few seconds then press the **“V” button** or **“1” button**.

3. The three red **System Control** LEDs and the auxiliary button **LEDs** will begin cycling. **Wait until the LEDs stop cycling.** The three System Control LEDs will start to blink on and off. The system is ready to enable the MobileTouch wireless controller. Continue with step 4. **See note on page 29 if using MobileTouch firmware version 1.160/2.160.**

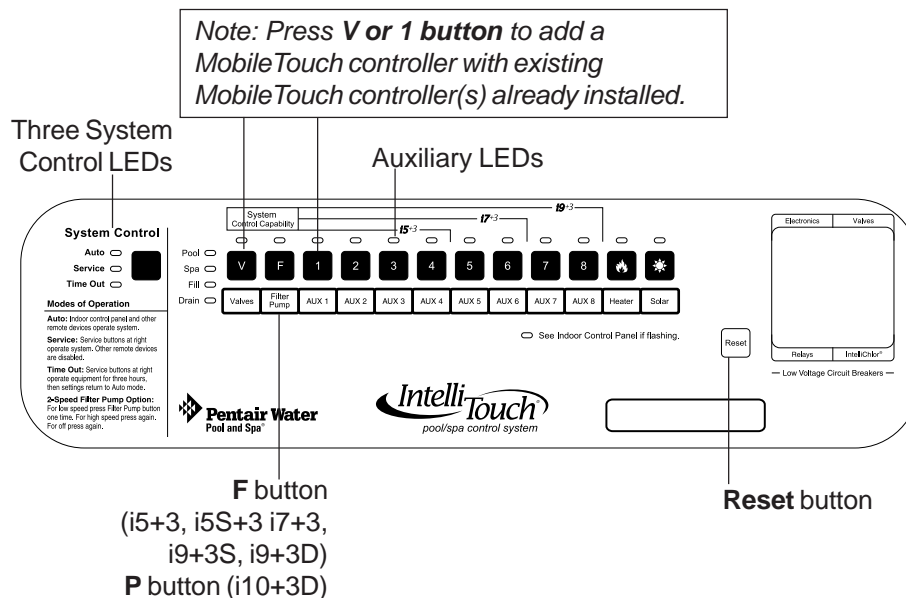

Go to the Advanced screen.

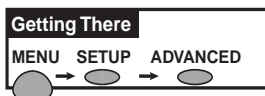

4. From the MobileTouch controller Advanced screen, press the **lower buttons 2 and 4 at the same time**. The Service Personnel screen will be displayed.

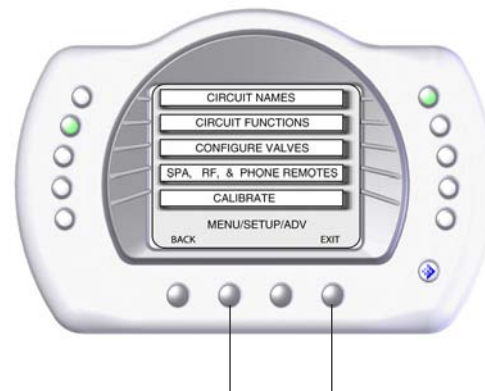

Press button **2 and 4** at the same time to access the Service Personnel screen

Setting up the MobileTouch Wireless Controller (Continued)

5. Press the button next to **LOCK ON ADDRESS** to access the next screen.

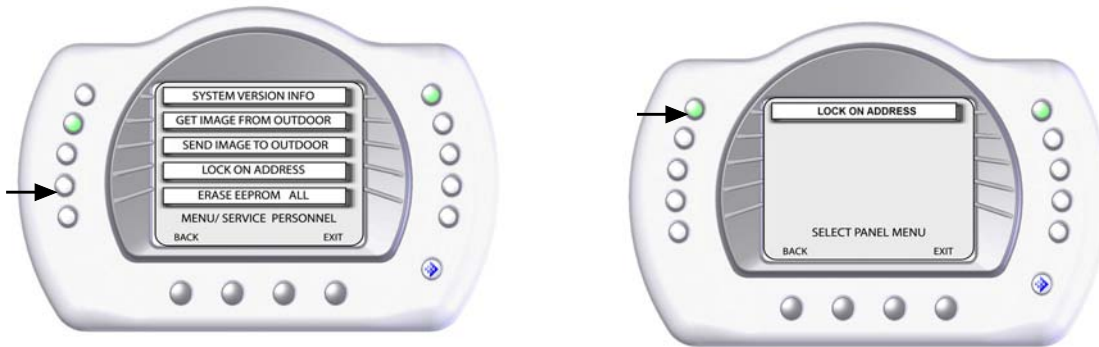

6. **Note:** Before pressing the “Lock On Address” move at least 20 to 30 feet away from the transceiver. Press the button next to **LOCK ON ADDRESS** to assign a unique frequency for the MobileTouch controller to avoid inference from other wireless devices within range of the MobileTouch transceiver.

Note: For MobileTouch firmware version 1.160/2.160: The "Lock On Address" line displays "**MAN ADDRESS LOCK AUTO**" - Press **AUTO** to lock on the address. If MobileTouch does not connect then use the MAN (manual) mode. You will notice on the IntelliTouch outdoor control panel there are three System Control LEDs flashing on and off. There are also two other LEDs going on and off. Watch these LEDs and you will see a pause, followed by one of the AUX 1 - 8 or Heater or solar LEDs flash on, then it goes off and a second LED will flash on. Then pause and repeat over and over. AUX 1 - 8 represent number 1 - 8, Heat = 9, and solar = 0. So if you see Pause, AUX 2, AUX 7, see Pause, AUX 2, AUX 7, etc. This indicates CHANNEL 27. The first LED is the 10's digit, the second LED is the ones digit. Press MAN on the address lock line, a new screen will appear, displaying **ENTER LOCK CODE**. Use the **LEFT and RIGHT buttons** to decrease or increase the number (16 to 47). So in this example you would set it to 27. Press **SAVE**, you will return back to the prior screen. Press the **RESET button** on the outdoor control panel and your MobileTouch is ready to use. If the MobileTouch is not connecting check your wiring connections.

7. After selecting “Lock On Address” the MobileTouch controller is now ready to operate the IntelliTouch system. The “Service Personnel” screen will be displayed.
8. Press **Exit** to return to the main screen or proceed with **Step 9** if you are adding another MobileTouch controller while the IntelliTouch outdoor control panel LEDs are flashing.
9. **To add another MobileTouch controller at this time**, repeat Steps 4 through 8 for each controller, if not, continue with Step 10.
10. Return the Load Center or Power Center. The System Control LEDs will be flashing. Press the **Reset** button. When the “Auto” LED is illuminated the process is complete and the system is ready for operation.

Adding an 10 Buttons Spa-Side Remote

Up to four SpaCommand spa-side remote controllers can be installed to allow each SpaCommand to operate different functions or to the same functions at different locations. Each SpaCommand can be assigned as number 1, 2, 3, or 4. If a different number is not assigned to each installed SpaCommand, then all SpaCommand's are assigned as number iS1. This is useful if you wish to have the same functions available at different iS10 locations. The following steps describe how to manually assign each SpaCommand a number 2, 3, or 4 as required.

Note: If the first SpaCommand was installed with the main Load Center or Power Center, it will automatically be assigned as number **IS1**. Other additional iS10 remotes need to be manually assigned.

To assign additional SpaCommand remotes as iS2, iS3, or iS4:

1. On the IntelliTouch Outdoor Control Panel, press the **Reset** button, then press the **1** button. The three (3) System Control LEDs will start flashing.
2. On the SpaCommand remote, press Down arrow bottom and the first button at the same time and the **1** button at the same time (while the Outdoor Control Panel LEDs are flashing).
3. **SHA** will be displayed on the remote temperature display. The four red remote LEDs adjacent to the in-line buttons will be lit.
4. Assign the remote to one of the following:
 - If this is the second remote 2 button 3 button 4 button IntelliTouch System
 - If this is the third remote, press button **#3**. The temperature display reads **IS3**.
 - If this is the fourth remote, press button **#4**. The temperature display reads **IS4**.
5. The two remote red toggle switch LEDs will start to flash.
6. On the Outdoor Control Panel, press the **Reset** button. The remote LEDs will stop flashing. Repeat steps 1-4 for additional SpaCommand remotes. To configure the SpaCommand buttons, see page 81.

Note: To disable or enable the Spa-Side Remote from the Indoor Control Panel or MobileTouch wireless control panel, refer to "Disable/Enable Spa-Side Remote," on page 83.

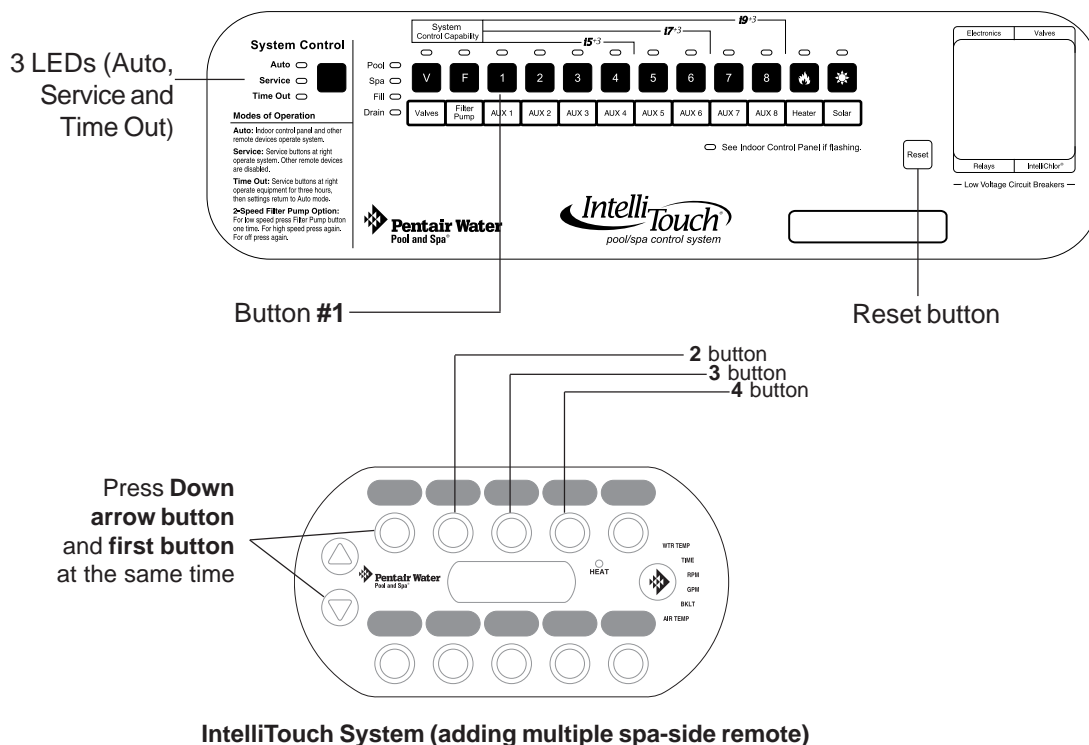

Prepare the System for Operation

If there are more than one Indoor Control Panel, you only need to configure one of the panels. Other Indoor Control Panels will be configured using these same settings. Before you start, make sure you have:

- Pen and paper
- Write in the circuit names in the provides labels under each button on the Outdoor Control Panel and the Circuit ID label worksheet (see page 89-94). Use a permanent marker, or other permanent means of labeling.
- If you are setting up a large system that covers a large area, ask your assistant to visually inspect the equipment while you test the circuits from the Outdoor Control Panel.

Note: To reset the system to the factory defaults, see “Erasing Outdoor Control Panel Memory (Factory Default),” on page 97.

Checking the Main Load Center

Use the following steps to check that the system is working correctly.

1. Switch on the AC electrical power at the house breaker.
2. Switch on the Load Center or Power Center. You may need to switch on the breakers on the Load Center.
3. Wait for the following:
 - On the Outdoor Control Panel check that the red **Auto** LED is on.
 - The LED next to **See Indoor Control Panel if Flashing** is not on.
4. Press the **Service** button to place the Load Center or Power Center in Service Mode for testing.

Note: for **i5+3**, **i7+3**, or **i9+3** systems, go to step 5. If you are working with the **i5S+3**, **i9+3S**, or **i10+3D** systems, skip step 5 and go to step 6. The IntelliTouch system model ID is located on the front of the Indoor Control Panel below the low voltage circuit breakers.
5. Press the **Valves (V)** button. Step through all four valve positions: Pool, Spa, Fill, Drain. Make sure the valves rotate to the correct position and the water is moving in the correct direction for each position. If necessary, flip the actuator toggle switch to change the direction of the water. After setting the valves and the system is in “Auto” mode, do not change the toggle switches.
6. Press the **Filter Pump (F)** button. Make sure the filter pump turns on correctly. If the pump has two speeds: Press the button one time to run the pump in low speed. Press the button again to run the pump in high speed. Press the button again to switch the pump off. A Two-Speed pump has to be configured from the EQUIPMENT screen.
7. Press each of the AUX buttons. Notice which button turns on which equipment. You may need to walk the property to find what each button turns on.

Checking the Main Load Center (Continued)

8. Press each AUX button to switch on each circuit. Affix a label under the appropriate button identifying the function and number of the circuit.
9. Repeat steps 4 through 9 for each Expansion Center. Note that **Aux 1** through **Aux 10** are used as circuit names on the Expansion Centers. Do not duplicate these circuit names with the circuit names of the main Load Center or Power Center.
10. The system is automatically configured if there is no more than one Load Center, one Expansion Center, an Indoor Control Panel, and one Spa-Side Remote. If there are additional Expansion Centers and/or controllers, then these need to be configured. For details about adding multiple Expansion Centers and controllers, see “Assigning Additional Expansion Centers” on page 27.

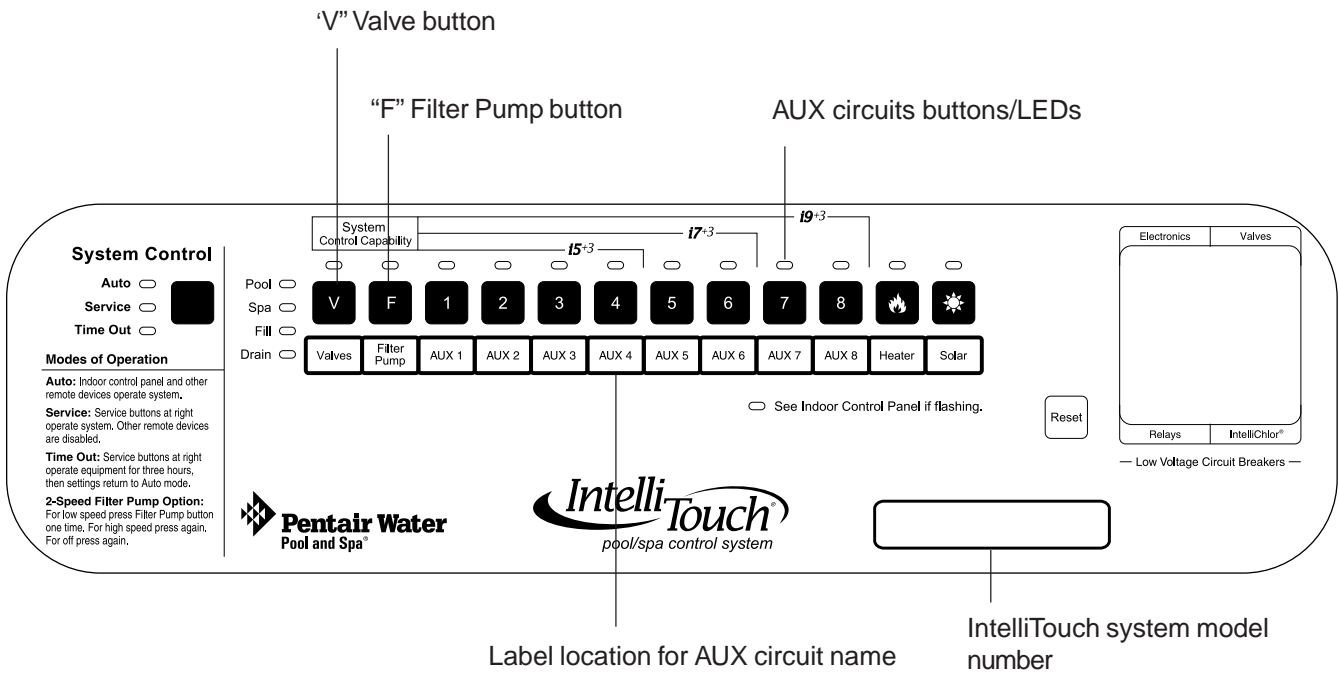

Setting up the IntelliTouch System using the Indoor Control Panel or MobileTouch

The following describes how to configure and set up the IntelliTouch system using the Indoor Control Panel or MobileTouch wireless control panel.

The Preference Screen Options

From the Preference screen you can change various screen options.

To change the screen settings go to the **Preferences** screen.



1. **To change the display backlight:** Press the top left or right side button to select the following options: **OFF IN 5 MIN**, **BLANK IN 5 MIN**, and **ALWAYS ON**.
2. **To change the display contrast:** Press the left button to decrease the display contrast level (lighter). Press the right side button to increase the display contrast level (darker).
3. **To change the brightness of the LED lights:** Press either the left or right side button to set the LED brightness level to **100%**, **75%**, **50%**, or **25%**.
4. **To change the display backlight brightness:** Press either the left or right side button to set the Backlight Brightness level to **100%**, **75%**, **50%**, or **25%**.
5. **To turn the button beeper sound off/on:** Press the button next to **User Interface**. From the next screen, press the button next to **Beeper Level** to **OFF**. To switch **ON** the sound, select **HIGH**. Press the **Back** button when finished.

Note about Key Repeat: It is recommended to leave the Key Repeat Delay and Rate set to the factory default setting (1/2 and 15 PS). The Key Repeat Delay adjusts the amount of time a key/button has to be held down before it starts auto-repeating. Key Repeat Rate adjusts the number of times per second (5, 10, 15, or 20 key repeats per second) the key/button repeats once it is held down.

6. When finished, to save the settings press the **Exit** button to return to the main screen.

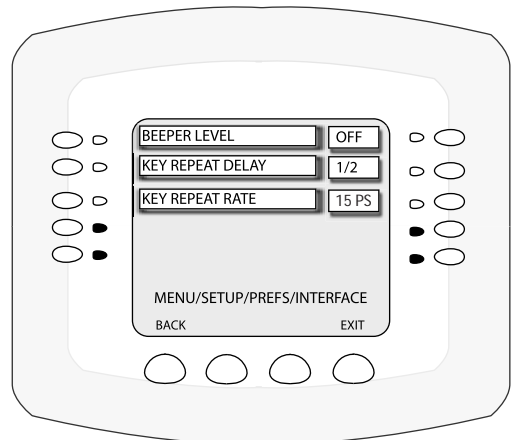
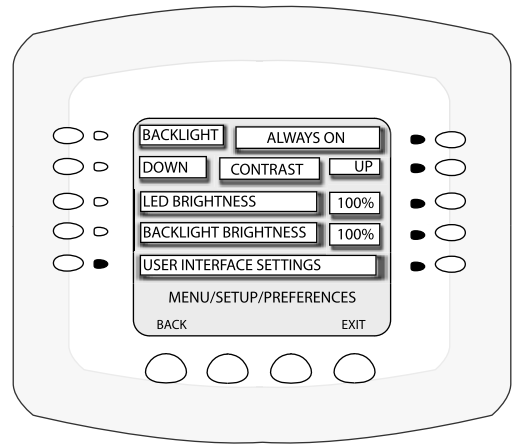

Set the System Clock

It's important to set the IntelliTouch system clock to the current time and date to ensure all automatic pool functions to work correctly.

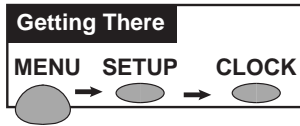

To set the system clock, go to the **Clock** screen.

1. Use the left or right side buttons to set each of the clock settings.
2. **Setting Daylight Savings:**
Set to **Auto** if you are in an area that observes Daylight Savings. Set to **Manual** if you are in an area that does *not* observe Daylight Savings.
3. **Setting clock accuracy offset:** To change the clock accuracy offset by seconds, press the right-side button to increase the offset and the left-side button to decrease the value. The offset value can be set from -300 to +300 seconds. If the internal system clock time is displaying ahead or behind the current time, use this the offset value to correct the clock.
4. Press the **Set** button to save the settings.
5. Press the **Exit** button to return to the main screen.

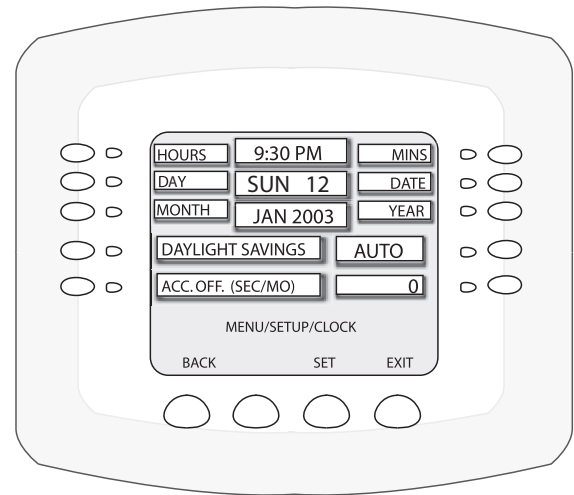

Assigning Circuit Names (for Display 1, 2, 3, and 4)

There can be up to four (4) Display screens that can be accessed, depending on the number of expansion Load Centers or Power Centers (see page 27 for more information). Assigning the system circuit names allows you to identify equipment from the Indoor Control Panel or MobileTouch wireless control panel. There are almost 100 preset equipment names to choose from (see page 37) to identify pool, spa and other related equipment. There are also 20 user-definable names to use for custom equipment if the preset circuit names are not suitable. Customizing names can also help identify unique system equipment. Assigning a custom circuit name to multiple circuits which then can be switched on or off from one button on the Indoor Control Panel or MobileTouch control panel. This method is called creating a MACRO (see page 80). For more information, refer to "Creating Custom Names for Auxiliary Circuits," page 38.

Note: The top left and right circuit names (**SPA** and **POOL**) on the main **DISPLAY #1**) should not be changed. These circuits have special reserved functionality that cannot be changed. The default circuits may be given any name but always perform in the same manner. Be careful not to duplicate circuit names with these circuits. These circuits may also be used to activate 2-speed pumps to high speed, turn additional valves, etc.

Selecting DISPLAY Screen 1, 2, 3, or 4

The auxiliary circuits that control the pool and spa equipment can be accessed from the “Display” screen on the Indoor Control Panel or MobileTouch wireless control panel. Selecting the button next to Display 1, 2, 3, or 4 displays the screen with circuits belonging to that particular expansion Load Center or Power Center. “Feature Circuits” can also be assigned from this screen. For more information about “Feature Circuits,” see page 76.

To assign circuit names for a specific display screen:

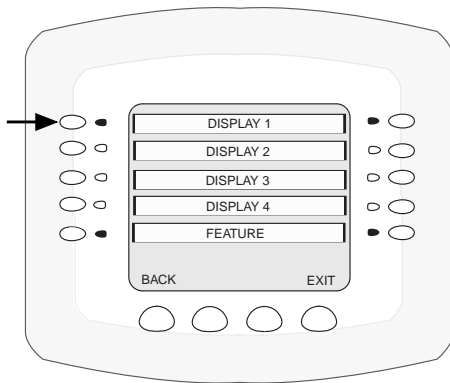
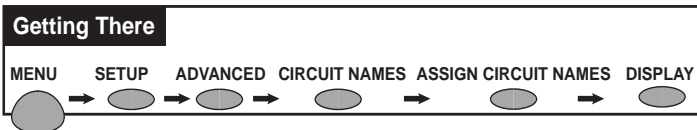

Display #1 - This screen shows circuit names for the filter pump, pool and spa modes, and all high voltage auxiliary circuits connected to the main Load Center or Power Center.

Display #2 - This screen shows circuit names for the additional auxiliary circuits connected to the first expansion center (Load Center or Power Center).

Display #3 - This screen shows circuit names for the additional auxiliary circuits connected to the second expansion center (Load Center or Power Center)

Display #4 - This screen shows circuit names for the additional auxiliary circuits connected to the third expansion center (Load Center or Power Center).

Assigning Circuit Names

In order to identify the equipment connected to the auxiliary circuits (SPA, AUX 1, AUX 2) in the Load Center, you need to assign equipment names to the corresponding auxiliary circuits in the Indoor Control Panel.

Using the written list of circuit names (button 1, button 2, etc.) made while setting up the system. Match the label name that was placed under each button (1, 2, etc.) on the Load Center Outdoor Control Panel with the selected circuit name that will be displayed on the “Main Display” screen.

Choose a circuit name from the preset list of names (see page 37) for equipment connected to the auxiliary relays installed in the main Load Center. There are also 20 user-definable names to use for other pool and spa related equipment if the preset circuit names are not suitable (see page 38).

To assign circuit names for the MAIN SCREEN:

1. Select the button next to Display #1 (Main Display screen, see page 7). These are the circuit names that will be displayed on the Main Screen. **Note:** *If there is an expansion Load Center or Power Center installed, select the appropriate Display #2, #3, or #4 associated with that expansion Load Center or Power Center.*
2. From the Main Display screen, press the button next to **AUX 1**. A small arrow pointing to AUX 1 is displayed.
3. Use the **Up** and **Down** buttons at the bottom of the screen to scroll through the alphabetical list of preset equipment names. Choose the equipment name that matches the label name for button number 1 on the Load Center Outdoor Control Panel.

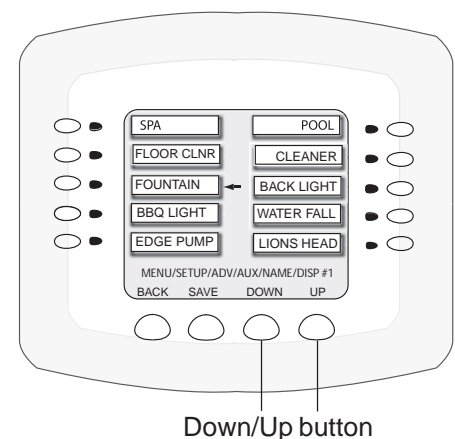

4. **Continue to name other auxiliary circuits (AUX2, AUX3, etc.):** After selecting the equipment name you want to use for **AUX 1**, press the button next to the **AUX 2** and choose a circuit name. The small arrow indicates which circuit is selected for naming.
5. Repeat the process to assign the other equipment to circuits on this screen.
6. When you have finished assigning equipment circuit names, press the **Save** button.
7. Press the **Exit** button to return to the Main screen.

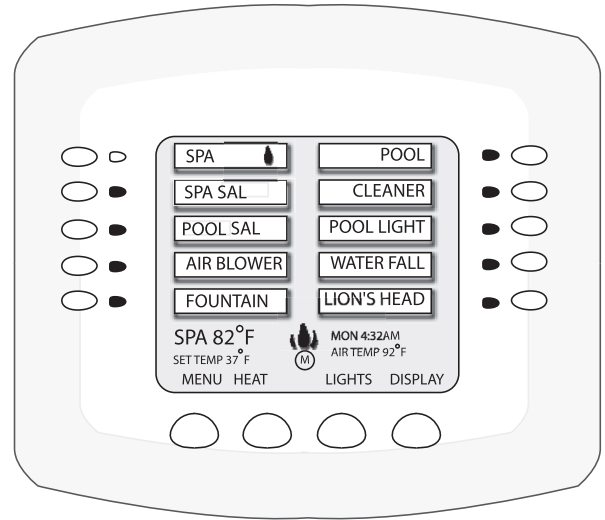

Selecting the Display Screens

There are three (3) screens to view and setup auxiliary circuits:

- **Main Screen:** Displays assigned auxiliary (AUX 1, AUX 2, etc.) circuit names. An **(M)** icon located in the middle lower part of the screen indicates that the “Main Screen” is selected.
- **Display #1:** Displays the auxiliary (AUX 1, AUX 2, etc.) circuits connected to the main Load Center. The number **(1)** icon located in the middle lower part of the screen indicates that circuits for Display #1 is selected.
- **Display #2, #3, or #4:** Displays the auxiliary circuits connected to additional expansion Load or Power Centers. The number **(2)** icon located in the middle lower part of the screen indicates that circuits for Display #2 is selected.
- **Feature:** Displays auxiliary circuits configured as “Feature” circuits. The **(F)** icon located in the middle lower part of the screen indicates that Feature circuits screen is selected.

To select the Display screens, press the lower right **DISPLAY** button to toggle through each of the screens. For more information, see page 7.

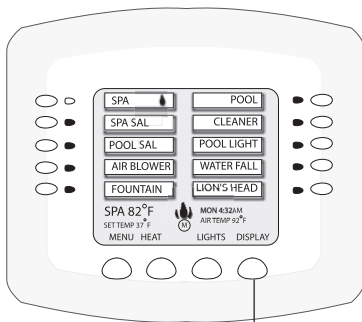

Display button

Main screen

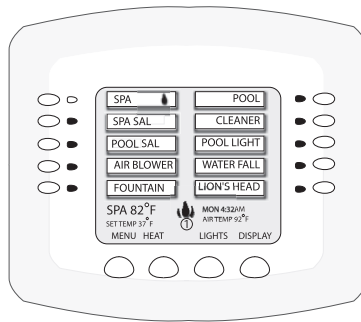

Display #1, #2, #3, or #4 screen

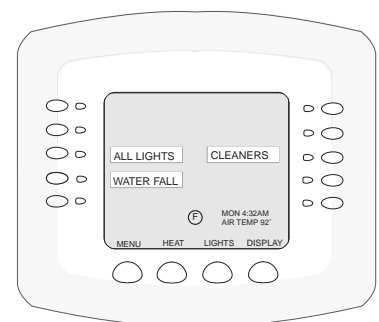

Feature circuits screen

IntelliTouch Circuit Names

AERATOR	(NOT USED)	Custom Names (11 characters maximum)	
AIR BLOWER	OZONATOR	USER NAME 01	_____
AUX 1	PATH LIGHTS	USER NAME 02	_____
AUX 2	POOL SAM 3	USER NAME 03	_____
AUX 3	SECURITY LT	USER NAME 04	_____
AUX 4	SLIDE	USER NAME 05	_____
AUX 5	SOLAR	USER NAME 06	_____
AUX 6	SPA	USER NAME 07	_____
AUX 7	SPA HIGH	USER NAME 08	_____
AUX 8	SPA LIGHT	USER NAME 09	_____
AUX 9	SPA LOW	USER NAME 10	_____
AUX 10	SPA SAL	USER NAME 11	_____
BACKWASH	SPA SAM	USER NAME 12	_____
BACK LIGHT	SPA WTRFLL	USER NAME 13	_____
BBQ LIGHT	SPILLWAY	USER NAME 14	_____
BEACH LIGHT	SPRINKLERS	USER NAME 15	_____
BENCH	STREAM	USER NAME 16	_____
BLOWER	STATUE LT	USER NAME 17	_____
BOOSTER PUMP	SWIM JETS	USER NAME 18	_____
BUG LIGHT	WTR FEATURE	USER NAME 19	_____
CABANA LTS	WTR FEAT LT	USER NAME 20	_____
CHEM. FEEDER	WATERFALL		
CHLORINATOR	WATERFALL 1		
CLEANER	WATERFALL 2		
COLOR WHEEL	WATERFALL 3		
DECK LIGHT	WHIRLPOOL		
DRAIN LINE	WTRFL LGHT		
DRIVE LIGHT	YARD LIGHT		
EDGE PUMP			
ENTRY LIGHT			
FAN			
FIBER OPTIC			
FIBERWORKS			
FILL LINE			
FLOOR CLNR			
FOGGER			
FOUNTAIN			
FOUNTAIN 1			
FOUNTAIN 2			
FOUNTAIN 3			
FOUNTAINS			
FRONT LIGHT			
GARDEN LTS			
GAZEBO LTS			
HIGH SPEED			
HIGH TEMP			
HOUSE LIGHT			
JETS			
LIGHTS			
LOW SPEED			
LOW TEMP			
MALIBU LTS			
MIST			
MOTOR VALVE			
MUSIC			

Creating Custom Names for Auxiliary Circuits

There are twenty user-definable names available to identify custom equipment if the preset circuit names are not suitable (see page 37 for the complete list of preset names). To create a custom name, choose one of the twenty user names and change it to your name of choice. For example, USER NAME-01 could be changed to LION'S HEAD for a waterfall or fountain. When assigning a Feature or Macro circuit (see page 79, 80), a user-defined circuit name can be assigned to multiple circuits which can be switched on or off from one button on the Indoor Control Panel or MobileTouch control panel.

To create a custom circuit name go to the **Create Custom Names** screen.

Note: Before creating a custom circuit name, first assign a function to the circuit (see page 39).

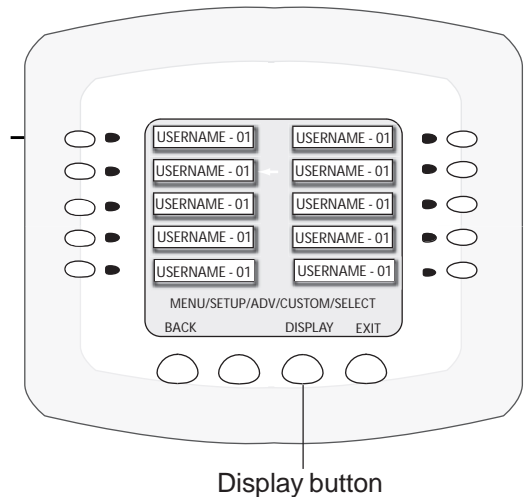
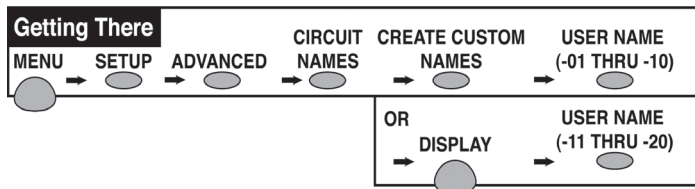

1. Press the button next to **USERNAME-01** to access the next screen to create a new circuit name. Up to ten user-definable names (01-10) can be created on the first screen and ten on the next screen (11-20). Press the **DISPLAY** button to toggle between the two screens.
2. To navigate through the alphanumeric characters use the left and right side buttons as shown below.
3. Once a character is selected, press the **SELECT** button then move to the next character. Use the **CLEAR** button to remove all characters.
4. Press the **Save** button when done. To create another custom circuit name repeat steps 1 through 4.
5. Press the **Exit** button to return to the main screen.
6. After creating a custom name, go to **ASSIGN CIRCUIT NAMES** (see page 35) and assign the custom name to the auxiliary circuit. The custom name(s) will be displayed in the list of circuit names (see page 37).

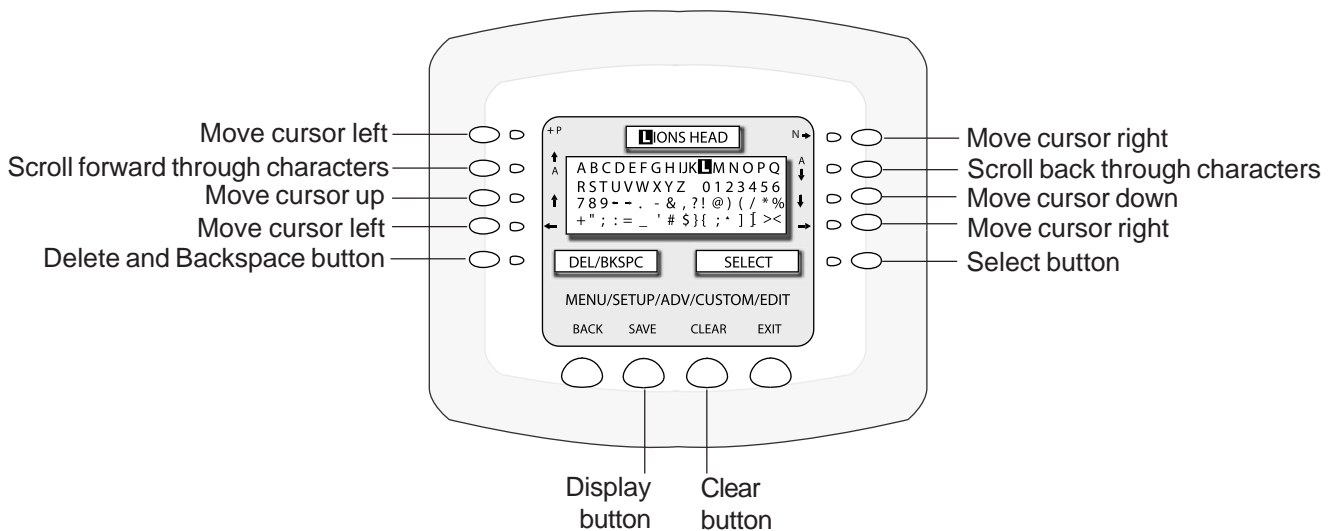

Assign Circuit Functions and Freeze Protection

Assigning a function to an auxiliary circuit allows certain type of equipment to operate in a specific way. For example, when setting up an automatic pool cleaner pump, you would assign the circuit function to MASTER CLEANER. With this "Cleaner" logic, when the circuit is switched on the cleaner pump would force the filter pump on, and start the cleaner pump after a delay of five (5) minutes. The cleaner pump would automatically shut off whenever the spa and solar is switched on with the cleaner pump (after a delay of five (5) minutes) if energy from the solar is required.

Freeze Protection

Freeze protection switches a circuit on if the outdoor air temperature sensor detects the temperature is getting close to freezing (below 36° F (2 ° C)). The system switches on all circuits that have been assigned freeze protection, and switches on the filter pump to circulate water throughout the system for 15 minutes to stop the pipes from freezing. This is especially important for a pool and spa combination (dual body shared equipment). If freeze protection is set to both the spa and pool circuits, the filter pump switches on and the pool and spa valves alternate every 15 minutes to keep the water moving through both the pool and spa. This process continues until the freeze condition is over.

Assigning a function and freeze protection to a circuit

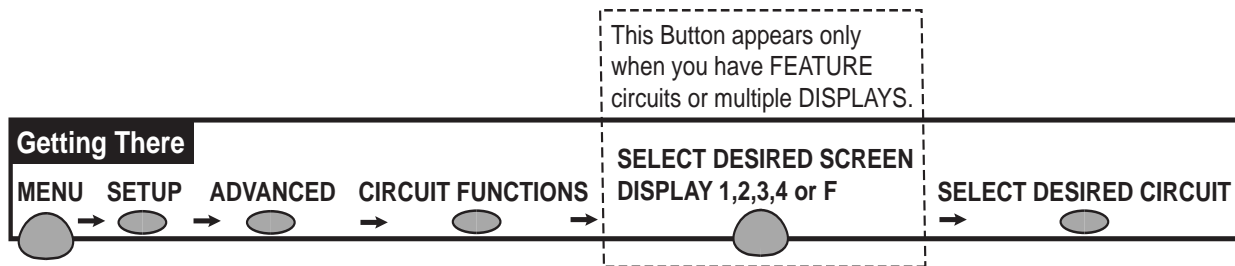

To assign a function to an auxiliary circuit and to add circuit freeze protection:

1. Press the button next to the circuit name that requires a function.

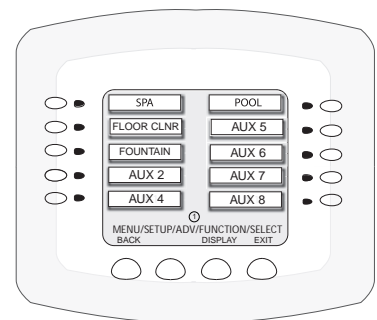

2. Press the lower DISPLAY button to view the Feature circuits. Select the Feature circuit name to assign a function to it. Use this button to toggle between the Feature circuit screen and the Circuit screen.

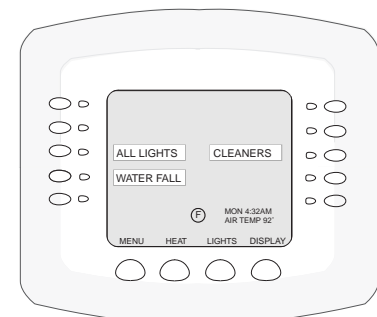

Assigning a function and freeze protection to a circuit (Continued)

To assign a function to an auxiliary circuit and to add circuit freeze protection:

1. Press the top right side button next to the displayed circuit names (i.e., CLEANER). The circuit displayed is selected from the previous screen.
2. Use the left and right side button next to PREV and NEXT to select the function for this circuit. For example, circuit function MASTER CLEANER selects the type of logic needed for a cleaner circuit. To assign a light function, select IntelliBrite, SAM Light or SAL Light. For the complete list of circuit functions, see Special Functions for Circuits, on page 41. **Note:** When using “pressure cleaners” assign the circuit to “Master Cleaner.”
3. Use the left and right side button next to ON WITH FREEZE to select **YES** for freeze protection. This will activate the circuit if the air temperature drops below 36° F (2° C). Select NO for no freeze protection. **Note:** Freeze protection is automatically enabled for SPA, POOL, HI-TEMP, and LOW-TEMP circuits.

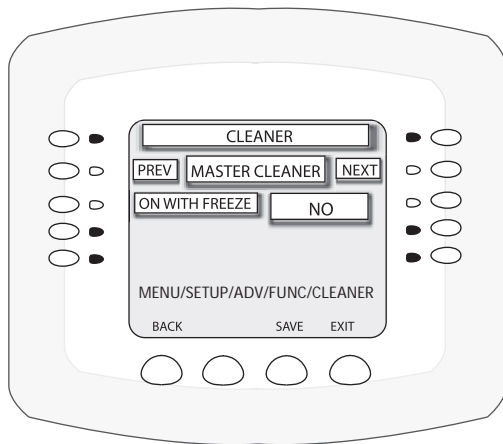

Note: Spa operation and freeze protect time: Using the “Spa Freeze Override” feature, the freeze protect default time of 30 minutes can be increase from 30 minutes to 240 minutes maximum. For more information, see page 71.

4. Press the **SAVE** button when finished.
5. Press the **BACK** button to return to the Circuits screen and repeat steps 1 through 4 to assign functions to other circuits.
6. Press **EXIT** button to return to the Main screen.

Special Functions for Circuits

Generic	No special Logic. Simple On/Off control of a circuit with all the programmable capabilities.
Master cleaner	Works with automatic pool cleaner pumps or cleaner valve actuator. It does the following: <ul style="list-style-type: none"> - Forces the filter pump on 5 minutes before the cleaner. - Turns the cleaner off when the spa is on. - Turns the cleaner off for 5 minutes when the solar heating begins.
Light	Allows special lighting features to work, such as ALL lights on or ALL lights off.
Dimmer	Allows light dimming features to work. Dimming relay must be installed.
SAM Light	Activates special color lighting programs on other screens on the Indoor Control Panel when used with SAM pool lights. For example, you can have ALL lights on or ALL lights off, or use Color Swim, Color Set, or Color Synch.
SAL Light	Activates special color lighting programs on other screens on the Indoor Control Panel when used with SAL spa lights. For example, you can have ALL lights on or ALL lights off, or use Color Swim, Color Set, or Color Synch.
Photon Generator	The Photon Generator® light source allows the Fiberworks fiber optic bulb be operated by Color Set or Color Swim programs when used with SAM and SAL lighting.
Color Wheel	Activates special color lighting programs on other screens on the Indoor Control Panel when used with Fiberworks.
Valve	Not currently used.
Spillway	For pool/spa combinations where the spa is raised above the pool. This setting moves the return valve so that the filter pump pulls the water from the pool and returns it to the spa, creating a water fall effect. Automatic pool cleaners are turned off when this feature is turned on.
Floor Cleaner	Rotates a 3-way valve every 20 minutes alternating flow between two cleaner system valves that feed the pop-up heads.
IntelliBrite	Activates an IntelliBrite LED light.
MagicStream	Activates a MagicStream laminar water feature.

Note: **Assigning Floor Cleaner function:** If a multi-head (six head) in-floor cleaner system or an IntelliFlo pump is being used, assign the equipment to the “GENERIC” circuit function, **not** the “Floor Cleaner” function. Assigning the “Generic” circuit function ensures that the pump will not ramp up and down every 20 minutes.

Setting up Lighting Options (Color Swim and Color Set) - Requires use of at least two SAm and/or SAL and/or Fiberworks Lighting products controlled by separate AUX circuits

There can be up to 12 light circuits on the main **Lights** screen. From this screen you can activate the “Color Swim” and Color Set” special lighting features. These special features each must have their own relay and separate circuits.

Color Swim and Color Set

Although the same screen is used to program the **Color Swim** and **Color Set** features, these two special lighting effects operate independently of each other. It may take up to a minute or more for Color Swim or Color Set to operate as programmed, depending on what kind of light you are activating and what state it was in when the effect was activated.

- **Color Swim** - Allows any combination of up to 12 *SAm*, *SAL*, and/or *FIBERworks* lighting circuits to be preset to transition through colors in sequence, giving the appearance of the colors swimming across the water. The delay in sequencing each light can be adjusted to customize the display for your pool. This feature requires the use of at least two *SAm*, *SAL*, and/or *FIBERworks* lighting products controlled by separate AUX circuits and relays.
- **Color Set** - Allows any combination of up to 12 *SAm*, *SAL*, and/or *FIBERworks* lighting circuits to be preset to specific colors. For example, you can set the colors for red, white, and blue, or red and green.
- **Sync** - Switches all color changing lights ON to synchronize their colors.
- **Smart Start** (SS_Yes and SS_No) - The Smart Start feature allows light circuits that are programmed to switch on at a specific time, automatically begin changing their colors. For more information see page 15.

Setting up Color Swim and Color Set with SAm, SAL, or FIBERworks

Both the **Color Swim** and **Color Set** feature can be configured and operated from the Lights screen, but operate independently of each other. Depending on what kind of light is being switched on and what state it was in when the lighting effect was activated, it may take up to a minute or more for Color Swim or Color Set to operate as programmed. The Color Swim feature creates the illusion of bands of colors moving through the water. This is accomplished by switching on each light with a specific color in a specified order at different time intervals. The order and time delay between lights can be mixed and matched to create many different effects. For example, colors moving left to right, one body of water to another, from the middle outward, etc.

To assign light circuits to the Lights screen:

Before Starting: Be sure the auxiliary circuits that control the lights have been assigned names. Then verify that *SAm* and *SAL* lights have been assigned in the “CIRCUIT FUNCTIONS” as *SAM* and *SAL* lights. If *FIBERworks* lighting is being used, it also has to be set up as a PHOTON GENERATOR for the circuit controlling the light bulb, and COLOR WHEEL for the circuit controlling the color wheel (see page 41).

Setting up Color Swim and Color Set lights

The following steps (see next page) describes how to setup an AUX circuit to control the Color Swim and Color Set lighting features. The first step is to assign the circuit light function an auxiliary relay circuit (AUX 1), then assign the circuit name for that light circuit. The light circuit name will appear on the main screen. Each light (*SAM* or *SAL*) must also be assigned a circuit function. If the circuit function has been assigned, start at Step 5 (see next page).

Setting up Set Colors and Color Swim with **SAm**, **SAL**, or **FIBERworks** (Continued)

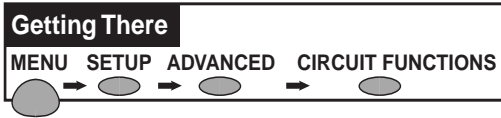

1. Press the button next to an available **AUX (AUX 1 - AUX 8)** button to assign a light function a circuit.

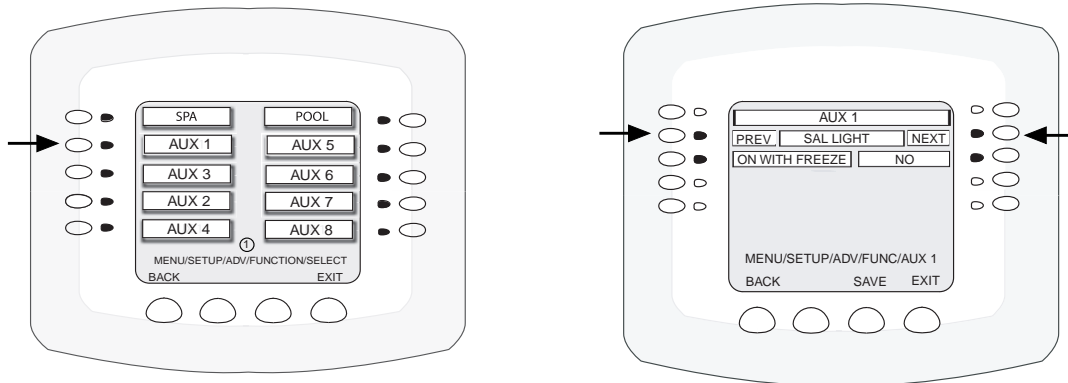

2. Press the right or left side **PREV/NEXT** button to scroll through the preset special circuit functions and choose a light selection (**LIGHT**, **SAM LIGHT**, **SAL LIGHT**, **PHOTON GEN**, **COLOR WHEEL**). See page 40 for the complete list of preset circuit functions. *Note: To use the Color Swim or Color Set feature you need to select SAM, SAL, Photon Generator or Color Wheel.*
3. Press the **SAVE** button on the bottom of the screen. To assign other circuits, press the **BACK** button and repeat step 2, and 3)
4. **Assign a name to the AUX circuit:** Press the **BACK** button two time until the Advanced screen is displayed..
5. Press the button next to **CIRCUIT NAMES**.
6. Press the button next to **ASSIGN CIRCUIT NAMES** to assign a name to the AUX (AUX 1-AUX) light circuit. From the Circuit Names screen you can assign circuit names for the main screen and create custom names.
7. Press the button next to **DISPLAY 1**. Display 1 is the main indoor control panel. If there are additional IntelliTouch Expansion Centers installed, Display 2, Display 3, and Display 4 will be displayed. Select which indoor control panel to configure. From this screen you can also configure Feature circuits.
8. Press the button next to the assigned AUX. A small arrow will appear next to the selected auxiliary circuit.
9. Use the **DOWN/UP** buttons select the name that you want to use for the light. For this example select **SPA SAL** for a spa light. Press the **SAVE** button on the bottom of the screen to save the name. Press the **EXIT** button when finished. Use this button to switch the light on and off.
10. Proceed to Step 11 to configure a SPA SAL light for the Color Swim of Color Set lighting feature:.

To configure the SPA SAL light for the Color Swim of Color Set lighting feature:

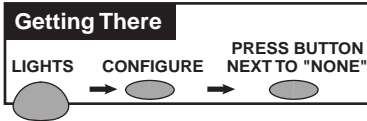

11. From the main screen, press the **Lights** button on the bottom of the screen.
12. Press the right or left side button next to CONFIGURE.

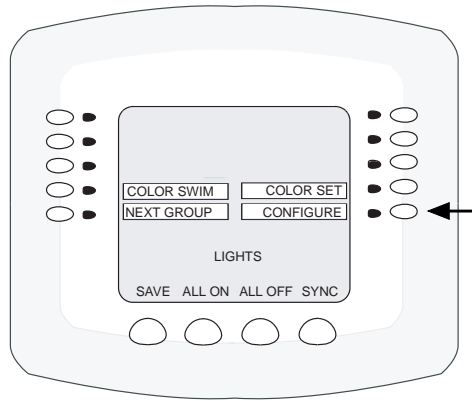

Lights screen

13. Press the button next to NONE to assign a light circuit to the selected button. Light names can be setup to display on the left side for “Spa” features and on the right side for the “Pool” features.

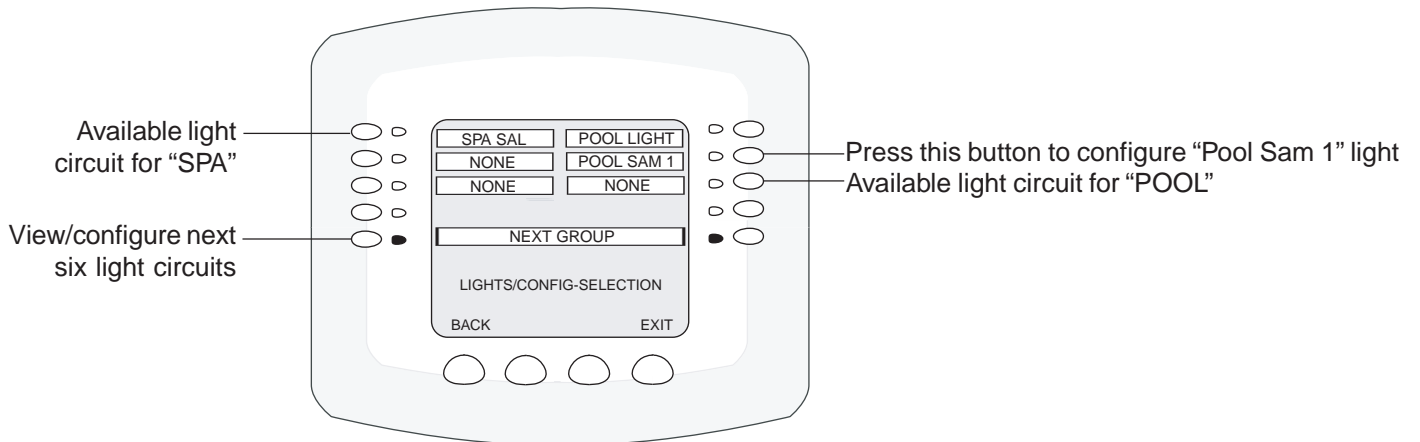

Setting up Set Colors and Color Swim with SAm, SAL, or FIBERworks (Continued)

14. Press the top left or right side button to scroll through the available light circuits which can be used for the Color Set and Color Swim feature. Stop at the circuit name you wish to use. The displayed circuit names selections are circuit names that were previously assigned (when assigning a circuit function). If there are no circuits available for selection, refer to “Assigning Circuit Names,” on page 3, and “Assigning Circuit Functions and Freeze Protection” on pages 39 for more information.

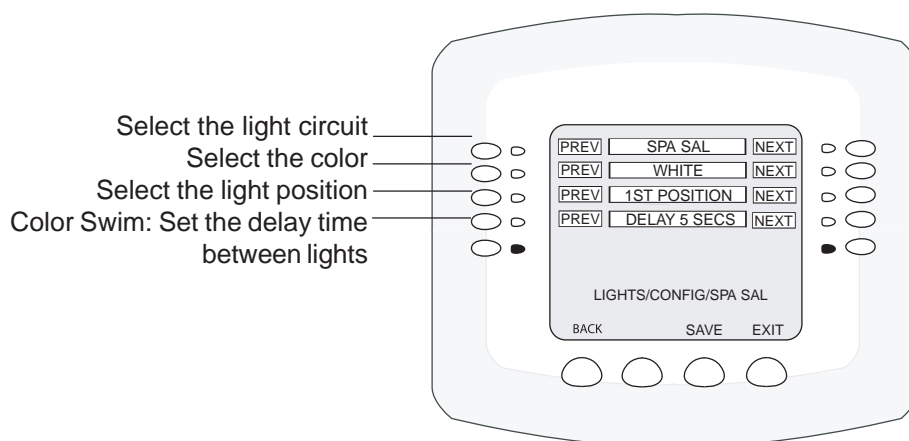

15. **Using the Color Set feature:** Press the second button down from the top to scroll through the color choices. Select the color of your choice. The selections are, White, Light Green, Cyan, Blue, Lavender, Magenta and Light Magenta.
16. **Set Light Position:** Press the third button down from the top to set the position of the first light in the sequence. **Position 1** will lead all the other lights in the color changing sequence. **Position 2** follows Position 1 and so on. There are 12 position to choose from. More than one light may be assigned to the same position number so that their colors may be synchronized. For example, to make the colors swim right to left, make your right most light POSITION 1. You may need to go back to Step 1 and scroll through your lights to find the right most light, and set it as POSITION 1.
17. **Using the Color Swim feature:** Press the fourth button down from the top to set the time delay between this light and the previous position. Use a higher delay time for lights spread further apart. Try five seconds for all lights and observe the effect. Use different time settings to achieve unique lighting moods and effects.
18. Press the **Save** button to save the current setting for the first light. The previous “CONFIGURE-SELECTION” screen is displayed. Continue to setup the light circuits. Press the button next to “NEXT GROUP” to access the next screen for an additional six circuits. Repeat step 1 through 5 to set the light for POSITION 2 for Color Swim, and a new color choice for Color Set. Press Save. Repeat this process until all desired lights have set colors, positions and delays.

19. Press **Back** to view the Lights screen. “SPA SAL” on and off switch is now assigned to the AUX 1 button.

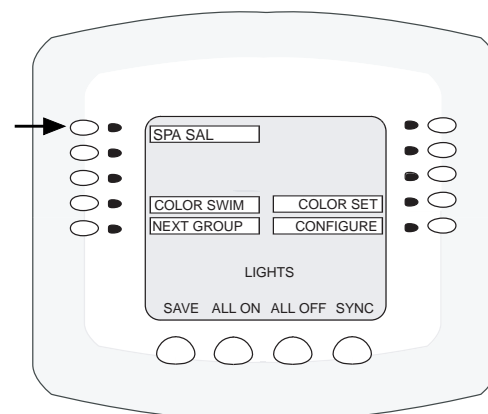

Setting up IntelliBrite LED lights

Up to twelve (12) IntelliBrite light circuits can be displayed on the main Lights screen. From the Lights screen you can activate the IntelliBrite lighting features (i.e., color swim, color set). Assuming each IntelliBrite light has its own relay and separate circuit. The IntelliBrite LED (light-emitting diode) underwater light system provides brilliant vivid colors with spectacular effects for your pool, spa and landscape lighting features. Each of the energy efficient IntelliBrite colored LED arrays can be individually controlled to custom create any color sequence of the rainbow spectrum. The IntelliBrite LEDs can be set to activate and cycle through colors at varying speeds, in different sequences of color.

Setting up IntelliBrite Lights

To setup IntelliBrite LED light circuits, first assign each light auxiliary relay circuit a circuit name, then assign that light relay circuit in the “CIRCUIT FUNCTIONS” section, as “INTELLIBRITE.”

To setup the IntelliBrite light circuits:

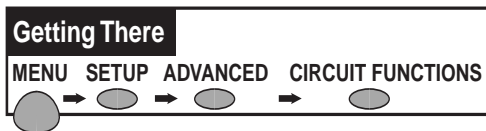

1. Press the button next to the AUX button (the relay auxiliary circuit connected to the IntelliBrite light).

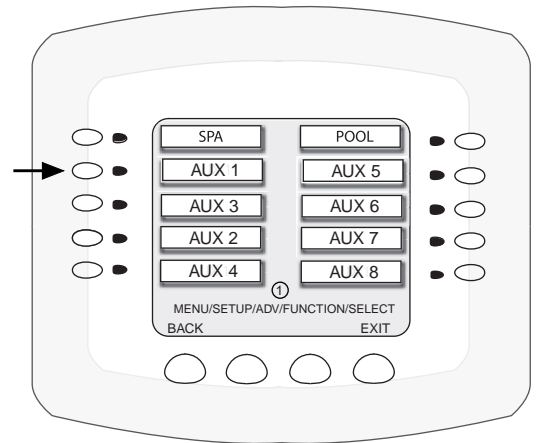

2. Press the right or left side (PREV/NEXT) button next to “INTELLIBRITE.” Scroll through the circuit functions until “INTELLIBRITE” is displayed. See page 41 for the complete list of preset circuit functions.
3. Press the SAVE button on the bottom of the screen. Press the EXIT button to return to the main screen.
4. Proceed to Step 5.

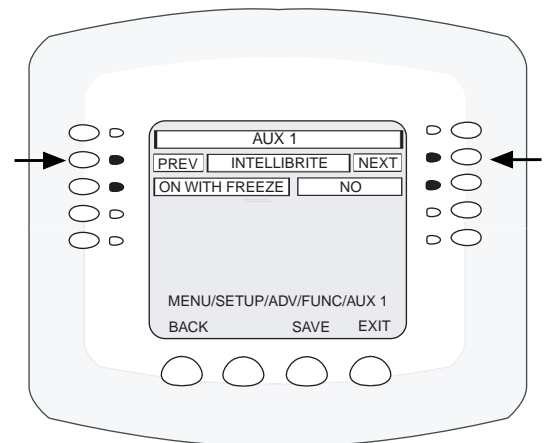

Setting up IntelliBrite LED lights (Continued)

To assign IntelliBrite light circuits to the Lights screen:

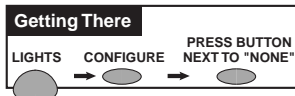

5. Press the Lights button on the bottom of the screen.
6. Press the right side button next to "CONFIGURE."

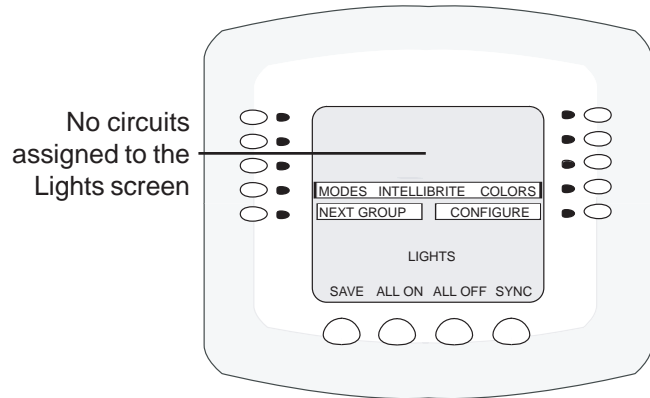

Lights screen using IntelliBrite lights

7. Press the button next to "NONE" to assign an IntelliBrite light circuit to the selected button. Light names can be setup to display on the left side for "Spa" features and on the right side for the "Pool" features.

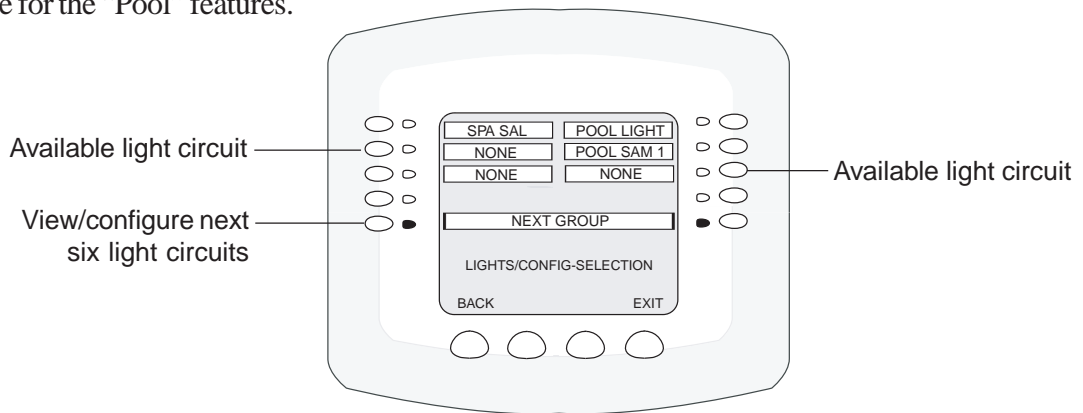

8. Press the top left or right side button to scroll through the available light circuits which can be used for the IntelliBrite lighting features. Select at the circuit name you wish to use. The displayed circuit names are circuit names that were previously assigned when assigning a circuit function. If there are no circuits available for selection, refer to "Assigning Circuit Names," on page 35, and "Assigning Circuit Functions and Freeze Protection" on page 39 for more information.

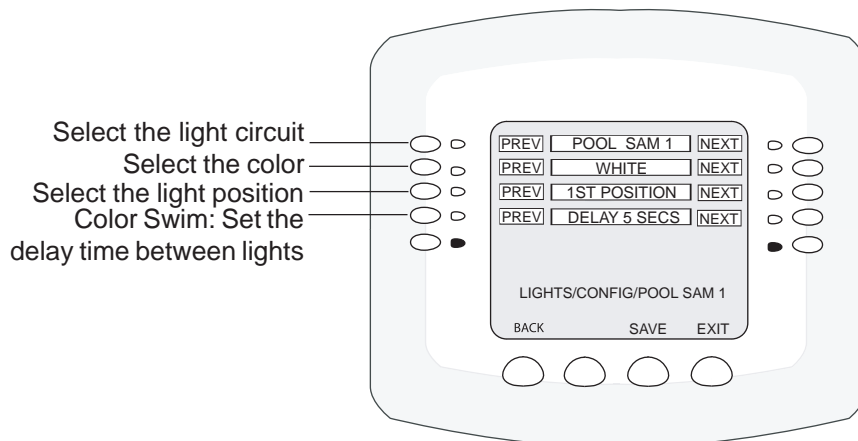

Setting up IntelliBrite LED lights (Continued)

Selecting IntelliBrite Modes

From the “Modes” screen you can select various preset show color lighting effects, such as “American mode” and “Sunset mode,” and Sam Style (an emulation of the SAM color scheme). Using the “Hold” and “Recall” feature (see page 49) you can also capture and save a unique color effect to recall at a later time.

Modes screen

To access the IntelliBrite “Modes” features from the Lights screen, press the **Lights** button on the bottom of the screen, then press the left side button next to “MODES.”

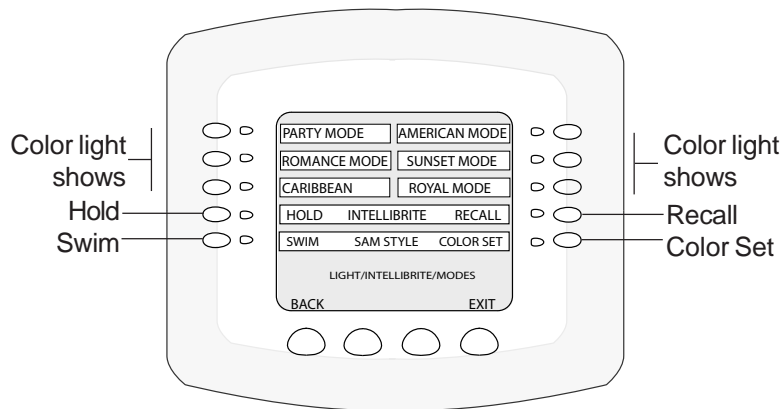

WARNING - During the off/on switching process, before the selected color is displayed, no illumination will occur. This operating mode is normal during the switching process. During this period the pool and spa will be dark and precautions should be taken to avoid unforeseen accidents. Failure to observe this warning may result in serious injury or death to pool and spa users.

Modes: Color light shows

There are six pre-programmed color light shows available to enhance your backyard pool environment.

Note: If the light was not previously on, after pressing a color show mode button, no illumination will occur for up to ten (10) seconds (depending on the selection), then a white light will momentarily illuminate, followed by the color show mode selection. If the light was previously on, pressing the a color show mode button will momentarily illuminate the previously selected color before changing to the selected color show.

- **SAM mode:** Emulates SAM lights color scheme
- **Party mode:** Rapid color changing building the energy and excitement
- **Romance mode:** Slow color transitions creating a mesmerizing and calming effect
- **Caribbean:** Transitions between a variety of blues and greens
- **American Mode:** Patriotic red, white and blue transition
- **Sunset Mode:** Dramatic transitions of orange, red and magenta tones
- **Royalty Mode:** Richer, deeper, color tones

Feature: Swim

The “Swim” SAM Style feature cycles through white, magenta, blue and green colors. This feature emulates the “Color Swim” feature (see page 42).

Note: If the light was not previously on, after pressing the SWIM button, no illumination will occur for approximately six (6) seconds followed by the “COLOR SWIM” feature selection. If the light was previously on, after pressing the SWIM button, the previously selected color will momentarily illuminate, no illumination will occur for approximately six (6) seconds followed by the “COLOR SWIM” feature selection.

Setting up IntelliBrite LED lights (Continued)

Feature: Color Set

The “Color Set” SAm Style feature allows any combination of up to 12 IntelliBrite lights, and SAm, SAL and or Fiberworks lighting (see page 42) to be preset to specific colors. To enable this feature, first select the light color from the “Colors” screen, then press the button next to “Color Set” to change the lights to the selected color. **Note:** *If the light was not previously on, after pressing the COLOR SET button, no illumination will occur for approximately six (6) seconds followed by the “COLOR SET” feature selection. If the light was previously on, after pressing the COLOR SET button, the previously selected color will momentarily illuminate, no illumination will occur for approximately six (6) seconds followed by the “COLOR SET” feature selection.*

Fixed Colors Screen

There are five (5) fixed colors to choose from to create a spectacular underwater lighting effect. The fixed colors are: **Blue, Green, Red, White and Magenta.** You can switch each light on or off from this screen (see above) by pressing the button next to the name of the color light. **Note:** *If the light was not previously on, after pressing a color button, no illumination will occur for up to ten (10) seconds (depending on the selection), then a white light will momentarily illuminate, followed by the color selection. If the light was previously on, pressing the color button will momentarily illuminate the previously selected color before changing to the selected color mode.*

To select a fixed color:

1. To access the IntelliBrite fixed “Colors” screen from the Main screen, press the **Lights** button on the bottom of the screen, then press the right side button next to “COLORS.”
2. To activate a color, press the button next to the name of the color.

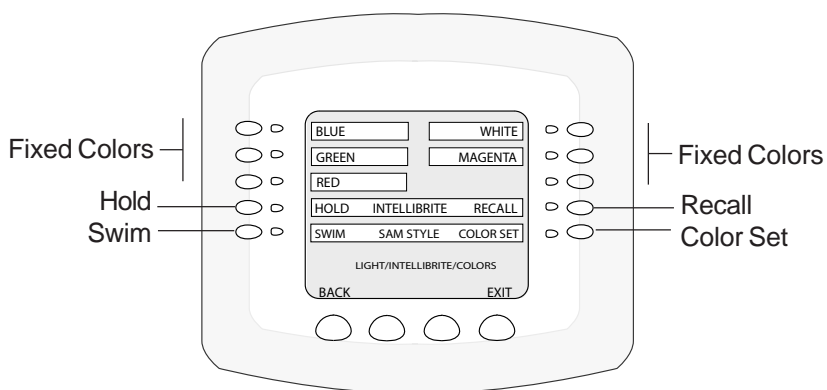
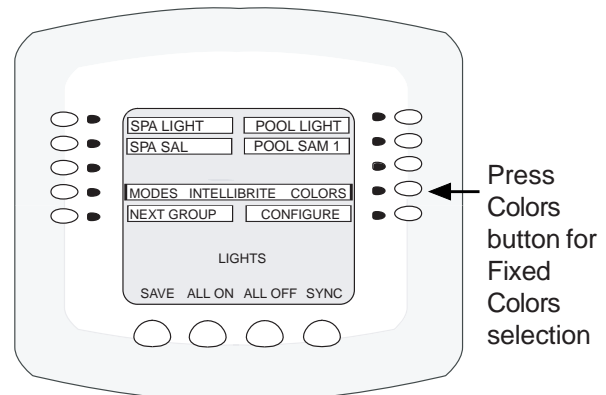

WARNING - During the off/on switching process, before the selected color is displayed, no illumination will occur. This operating mode is normal during the switching process. During this period the pool and spa will be dark and precautions should be taken to avoid unforeseen accidents. Failure to observe this warning may result in serious injury or death to pool and spa users.

Fixed Colors: Hold/Recall Feature

Use the “Hold” and “Recall” feature to capture and save the selected color and recall it at a later time. **Note:** *After pressing the HOLD or RECALL button, no illumination will occur for up to 10 seconds, then a white light will momentarily illuminate, followed by the saved color.*

Setting up MagicStream Laminars

The MagicStream Laminar provide a clear, turbulence-free stream of water that is lit with a fiber optic cable, or an LED light for a dazzling nighttime effect. The 12 VAC powered LED light can generate a series of multicolored light shows, or can be set to display a continuous, single color. If desired, the built-in solenoid “thumper” can create a random “wrinkle,” in the Laminar’s stream, causing it to display a brilliant spot of light that moves along the stream’s arc. The light enhancer can be adjusted to maximize the light in the arc.

Up to twelve (12) MagicStream Laminar circuits can be displayed on the main Lights screen, assuming each laminar has its own relay and separate circuit.. From the Lights screen you can activate the MagicStream laminars (changing color modes, turn Thumper on/off, Hold and Reset). For more information, see the MagicStream Installation Guide, P/N 520969.

Setting up MagicStream Laminar LED Lights

To setup MagicStream laminar circuits, first assign each laminar auxiliary relay circuit a circuit name, then assigned the laminar relay circuit name in the “CIRCUIT FUNCTIONS” menu, as “MAGICSTREAM.”

To setup the MagicStream laminar circuits:

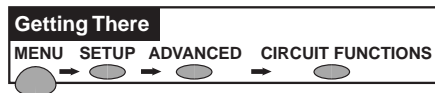

1. Press the button next to the AUX button (the relay circuit connected to the laminar).
2. Press the right or left side (PREV/NEXT) button next to “MAGICSTREAM.” Scroll through the circuit functions until “MAGICSTREAM” is displayed. See page 41 for the complete list of preset circuit functions.
3. Press the SAVE button on the bottom of the screen. Press the EXIT button to return to the main screen.
4. Proceed to Step 5.

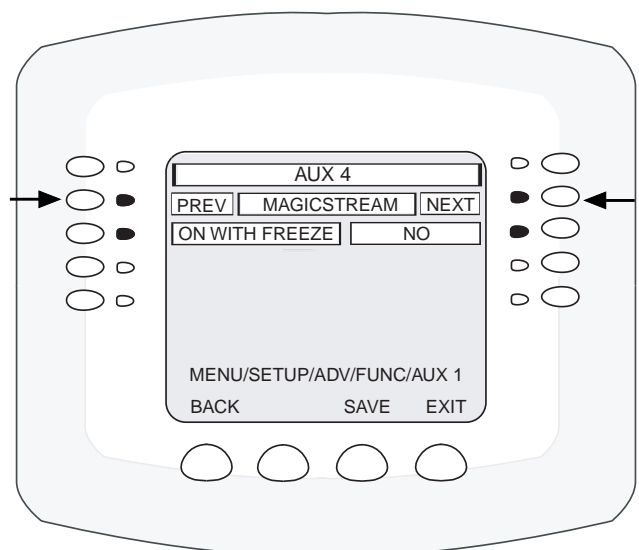
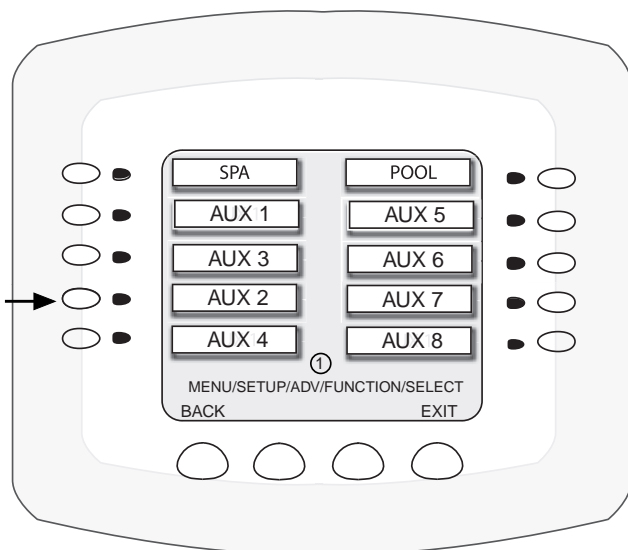

To display the assigned MagicStream circuit on the Lights screen:

- From the main screen, press the **Lights button** on the bottom of the screen.
- Press the right side button next to “CONFIGURE” to assign the previously assigned MagicStream laminar circuits to the “Lights” screen. Note: The screen on right shows IntelliBrite light circuits already displayed on the “Lights” screen. The MagicStream circuits are not displayed until assigned to the “Lights” screen.

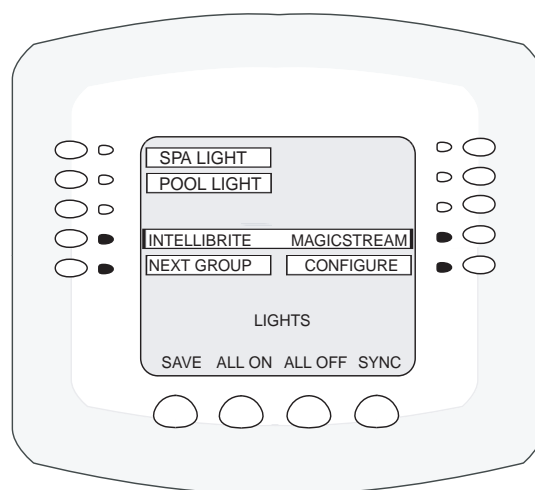

- Press the button next to “NONE” to assign a laminar light circuit to the selected button.
- Press the **top left or right side** button to scroll through the assigned light circuits. Select the previously assigned MagicStream circuit name (i.e. Pool Laminar 1) or AUX circuit. Repeat this step for other laminar circuits (i.e. Pool Laminar 1).
If there are no circuits available for selection, refer to “Assigning Circuit Names,” on page 35, and “Assigning Circuit Functions and Freeze Protection” on page 39 for more information.
- Press the **SAVE** button on the bottom of the screen. Press the **BACK** button to return to the main screen. The MagicStream laminar circuit will be displayed on the “Lights” screen, as shown below.

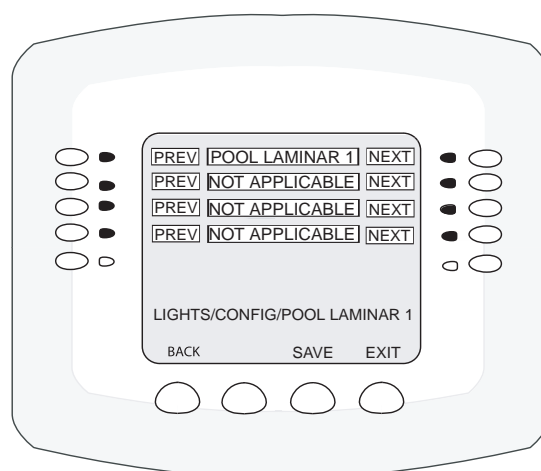

To activate the MagicStream features, see the next page.

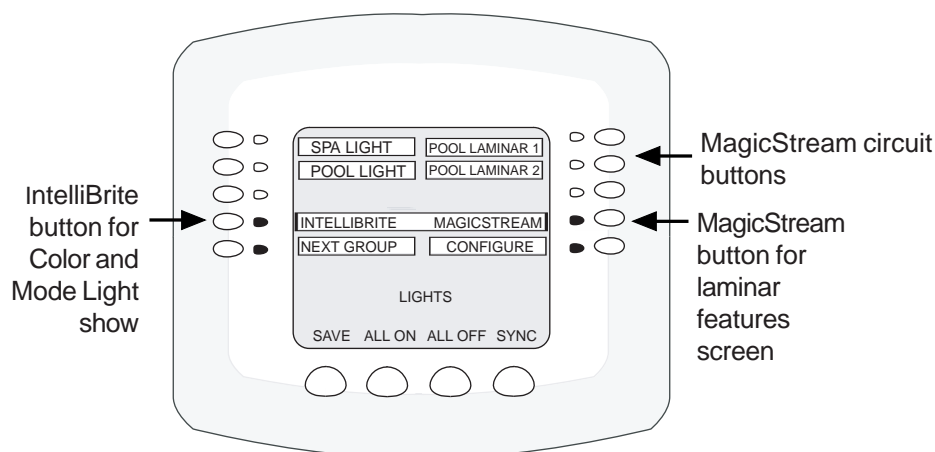

Lights screen using IntelliBrite lights and MagicStream laminars

Using the MagicStream Laminar Features

The MagicStream laminar features are displayed on the MagicStream screen. Each time the MagicStream laminar is switched on using the Light screen circuit buttons, it resumes with the same features in operation as when last switched off. The MagicStream features are as follows:

Thumper - Pressing this button creates a "wrinkle" in the laminar stream, producing a brilliant spot of light in the laminar arc.

Reset - Pressing this button reverts to the **Random** color changing mode with the Thumper ON.

Toggle Mode - Pressing this button (each successive OFF/ON combination) will cycle through **Sync**, **Random** and **Party**. Color changing mode - The color of the light changes automatically, according to one the following three programs:

Sync - Colors will change at ten second intervals. In this mode, multiple laminars will synchronize colors together. Note: To sync multiple laminars (two or more AUX circuits), be sure to define the "MagicStream" circuits in the Circuit Functions screen and also define the AUX circuits in the Lights screen (CONFIGURE, 0-6 or 7-12).

Random - Colors will change at ten second intervals in a random sequence. In this mode, multiple laminars will NOT synchronize colors together.

Party - Colors will change randomly and slowly at first, then speed up, until the sequence ends with quick flashes and strobes. The sequence then repeats, beginning with the slow changes. In this mode, multiple Laminars will NOT synchronize colors together.

Hold/Stop - Select Hold/Stop to capture the current color effect while colors are changing. The colors will stop changing. Selecting Hold/Stop again will resume the color changing mode.

To access the MagicStream laminar features screen:

1. From the main screen, press the **Lights button** on the bottom of the screen.
2. Press the button next to MAGICSTREAM to access the laminar features screen.
3. To activate a laminar feature, press the button next to the desired feature.

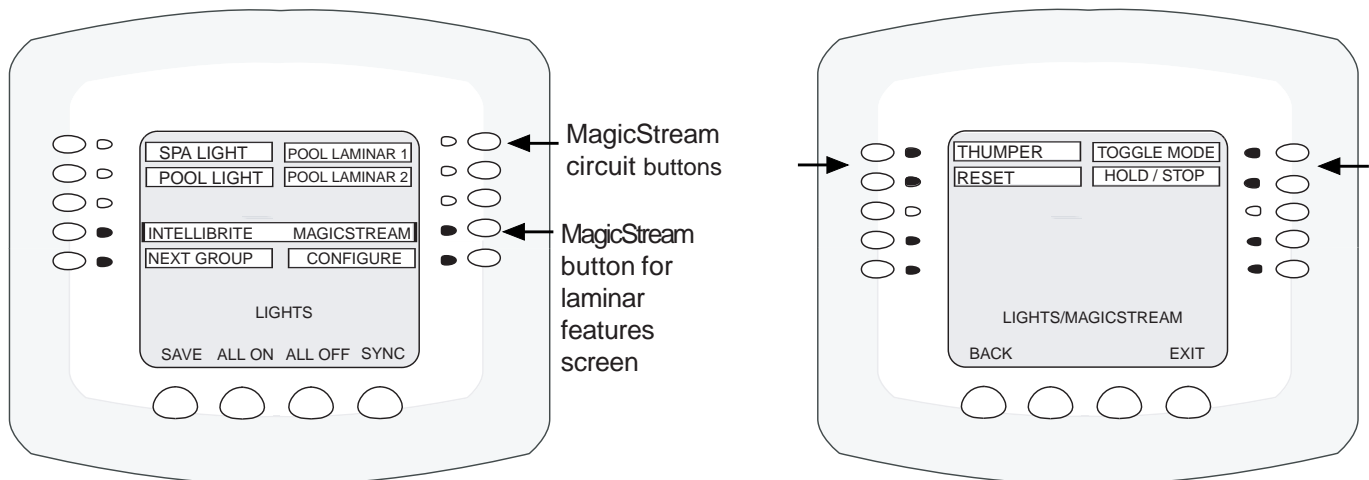

Setting up Equipment (from the Equipment Screen)

If any special equipment is attached to the IntelliTouch Load Center, you need to setup IntelliTouch to recognize that equipment. From the Equipment screen you can setup:

- **Priority override** - Allows you to manually switch off a pre-programmed circuit.
- **IntelliChlor** - Setup and view the correct status of the IntelliChlor salt chlorine electronic generator.
- **IntelliFlo VF, VS and SVF pump** - Setup and view the current status of the IntelliFlo pump circuits and program the pump speed (RPM/GPM).
- **UltraTemp heat pump** - Setup UltraTemp for heating, cooling or both.
- **Solar or heat pump equipment** - Lets you adjust solar settings or setup solar as a heat pump (see page 66).
- **Two-speed pump** - Assign a circuit to switch the filter pump to high speed.
- **Pump delays: Cool-down cycle for the heater** - Assign a circuit to program a cool-down delay cycle for the heater
- **Valve delay:** Enable a delay cycle for valves.
- **Spa Options:** Automatic spa heating when the spa is manually turned on - Heats the spa using the Spa button on the Indoor Control panel or the spa-side control, even when the heater is set to OFF in the Heat screen. This allows you to heat the spa on-demand. Also, on this screen you can override the default “freeze” setting of 30 minutes to a maximum of 240 minutes. Adjustments can be set in 30 minutes increments (see page 77).
- **Fahrenheit or Celsius:** Change the temperature settings units to display either Fahrenheit or Celsius.

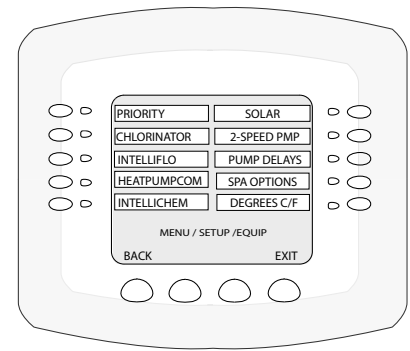

Equipment Screen

Manual Priority Override of Timed Program Circuits

The following example describes how the “Manual Operation Priority” feature affects scheduled programs.

Manual Op Priority OFF (Default): If the filter pump circuit or any other circuit is scheduled to run from 9AM to 4 PM and the circuit is manually switched OFF and switched ON within the scheduled program, the circuit will stop at 4:00 PM as scheduled. In this example the program was not overridden and continued to operate as scheduled.

Manual Op Priority ON: If the filter pump circuit or any other circuit is scheduled to run from 9AM to 4 PM and the circuit is manually switched OFF and switched ON within the scheduled program, the circuit will continue to run for a maximum of 12 hours or whatever that Egg Timer circuit was set to. In this example the scheduled program was overridden and reverted to the default 12 hour run time.

Note: Manual Op Priority OFF or ON: Using the above examples, if the circuit is manually switched on before or after the scheduled run time, the circuit will run for a maximum of 12 hours or whatever the time the Egg Timer has been set to. For information about the Egg Time feature, see page 17.

To enable Manual Op Priority press:

MENU > SETUP > EQUIPMENT > PRIORITY.

1. Press the top right or left button next to **Manual Op Priority** and select **Yes**.
2. Press **Save**.
3. Press **Exit** to return to the main screen.

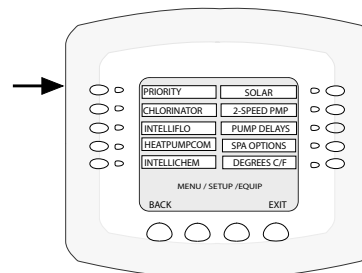

Chlorine Generator

The IntelliTouch system is designed to operate with the following salt chlorine generators:

- Pentair Water Pool and Spa® **IntelliChlor**®
- GoldLine **Aqua Rite**™
- Clear Tech Automation **AutoClear**® **Plus**
- AutoPilot **Pool Pilot**® **Digital**

Note: Call your manufacturer for compatibility with IntelliTouch systems.

Activating the Chlorinator

For IntelliTouch to control and operate the chlorinator, first enable the chlorinator from the IntelliTouch Indoor Control Panel. If the chlorinator control is enabled, the controls on the chlorinator are disabled and can only be operated by IntelliTouch. When the chlorinator control is disabled from IntelliTouch, the chlorinator will still be running but must be controlled at the chlorinator control panel.

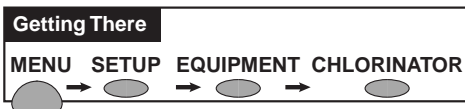

Go to the Chlorinator screen.

To view the chlorination status and adjust the spa or pool chlorination level:

- **STATUS:** Displays the current chlorinator operating condition. If a problem occurs with the chlorinator, an error codes will be displayed on the status line.
- **WATERSALT LEVEL:** Displays how much salt (in parts per million (ppm) is in the water. See chlorinator manufacturer's instructions for recommended salt levels.
- **SPA / POOL (0 -100%):** Displays the current spa and pool chlorination output level from 0 to 100%.
- **CONTROL ENABLED:** Press the button next to **YES** until **NO** is displayed to disable the control of the chlorination interface from the Indoor Control Panel.
- **To enable or disable the chlorinator:** Press the button next to **CONTROL ENABLED** and select **YES** to allow IntelliTouch to control of the chlorinator. Select **NO** to disable IntelliTouch control. Press **Save** when done to return to the Equipment screen.

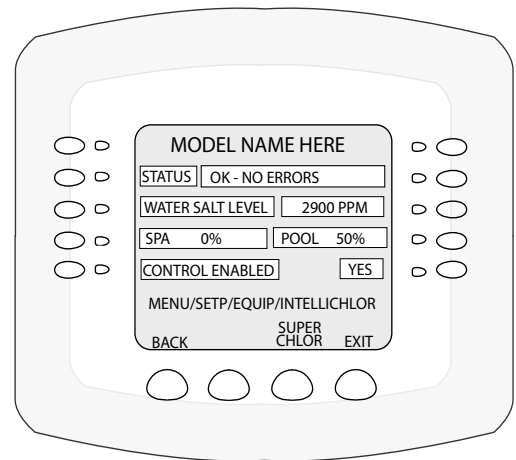

Adjusting the Chlorine Output Level

In an effort to prevent over chlorination of the spa, the IntelliTouch system will automatically drop the chlorine output levels to 1/20th of the current pool output when the spa is switched on. For example, if the pool output level is set to 60%, when the spa is switched on, the chlorination level is reduced to 3%.

- **To adjust the spa or pool chlorine output level:** Press the button next to **SPA / POOL**. Press the (-) or (+) button to decrease or increase the chlorine output level (from 0 to 100%) for the spa or pool water. Press **Save** when done to return to the Equipment screen. Press **Exit** to return to the main screen.

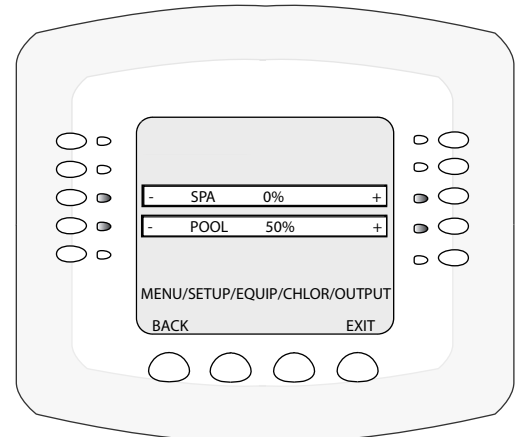

Spa and Pool Chlorine Output Level Screen

Super Chlorinate the Pool Water

Periodically, it may be necessary to “super chlorinate” the pool and/or spa.

Go to the Chlorinator screen.

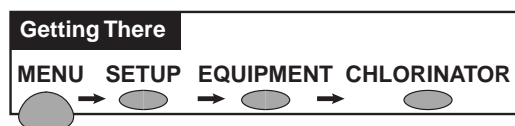

1. Press the **SUPERCHLOR** button.
2. The default run time for super chlorination is 24 hours. Press the buttons next to HOURS TO RUN to change the run time to super chlorinate.
3. Press **Save** when done. The chlorinator will start super chlorination mode (100%) and automatically switch on the filter pump. When super chlorination has been completed the system will return to normal operation.
4. **To cancel super chlorination:** Go back to the Chlorinator Screen. The time left for super chlorination is displayed.
5. Press the button under **Cancel Super Chlor.**
6. Press **Exit** to return to the main screen.

Note: For information about wiring a salt chlorine generator to the IntelliTouch system, see “Wiring IntelliTouch to a Salt Chlorine Generator,” on page 112.

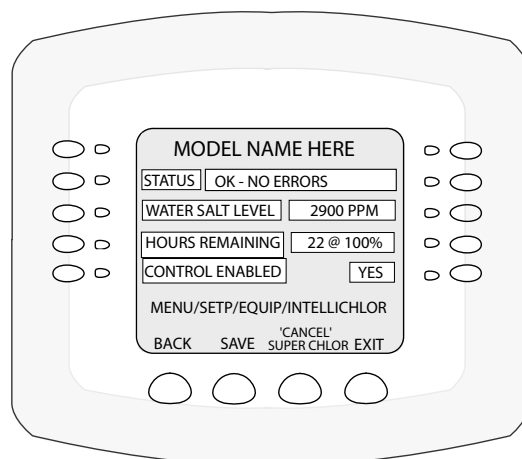
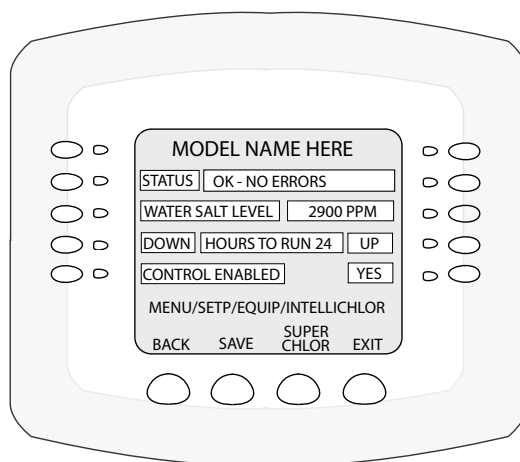

IntelliFlo VF 3050, VS 3050, VS+SVRS, VSF+SVRS Pump Setup

Setting up IntelliFlo

The IntelliFlo pump can be remotely controlled by an IntelliTouch system using the two-wire 50 foot RS-485 communication cable (P/N 350122). IntelliFlo operations can be adjusted from the IntelliTouch indoor control panel or MobileTouch wireless remote. For more information refer to the following manuals: IntelliFlo VF 3050 (P/N 350075), IntelliFlo VS 3050 (P/N 357269), IntelliFlo VSF+SVRS (P/N 351420)

How many pumps will IntelliTouch support?

IntelliTouch can support up to eight IntelliFlo VF and four IntelliFlo VS pumps in any combination with up to eight GPMs or RPMs per pump. For example pumps can be connected to IntelliTouch as follows:

- 8 IntelliFlo VF
- 7 IntelliFlo VF + 1 IntelliFlo VS (or VS+SVRS or VSF +SVRS)
- 5 IntelliFlo VF + 3 IntelliFlo VS (or VS+SVRS or VSF +SVRS)
- 4 IntelliFlo VF + 4 IntelliFlo VS (or VS+SVRS or VSF +SVRS (or only 4 IntelliFlo VS pumps)

Connecting power to an IntelliFlo pump

The IntelliFlo pump is designed to be permanently connected to its power source. Typically the pump receives power directly from the circuit breaker. No contactor or motor starter is required. The drive controls the starting and stopping of the pump. If the IntelliFlo pump is connected to an automation system, such as the IntelliTouch automation system, the drive must be powered up to receive and respond to the RS-485 serial communication from the automation system. However, the pump can be operated in “stand-alone” mode, starting and stopping when power is applied or removed. When the drive powers up it will return to the mode and run status that it was in when power was removed. This setup maybe appropriate if you need to use existing relays or timers.

Assigning an IntelliFlo VF 3050 pump address

Before assigning a pump address in the IntelliTouch indoor control panel, first set the address **on the pump itself**. If there is only one pump, it is always seen as pump #1 by IntelliTouch. In this case you do not need to set the pump address. When using multiple IntelliFlo pumps with IntelliTouch you need to assign an address to each pump. The address can be set to #1, #2, #3, #4, #5, #6, #7, or #8. The address set at the pump must match the IntelliFlo pump number selected in the IntelliTouch indoor control panel.

Note: IntelliFlo VF 3050 pumps cannot be connected in series with other pumps. Check valves must be used when a pump is used in parallel with other pumps.

To assign an IntelliFlo VF 3050 pump address:

1. Press the **Start/Stop** button to stop the pump. Be sure that the green power LED is on and the pump is stopped.
2. Press the **Menu** button.
3. Press the **Up and Down** arrow buttons to scroll through the menu items. Press the **Select** button to access the “Pool Data” menu.
4. Press the **Select** button to access the “Pump Address” setting.
5. Press the **Select** button to change the current pump address.
6. To enter the new address number, press the **Left** and **Right** arrows to select which digit to modify, then use the **Up** and **Down** arrows to change the selected digit.
7. When you are done assigning the pump address number, press the **Enter** button to save the changes. To cancel any changes, press the **Escape** button to exit edit mode without saving.

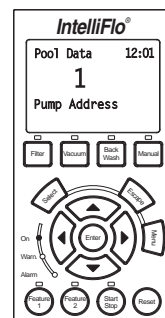
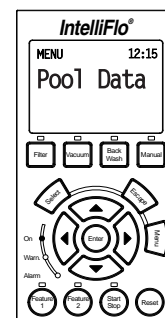

IntelliFlo menu options

To access the following IntelliFlo screens, press **MENU > SETUP > EQUIPMENT > INTELLIFLO**:

- **IntelliFlo main pump screens:** Two status screens (pumps 1-4, pumps 5-8), each displaying the IntelliFlo pump number assignments and assigned circuit name for each pump
- **IntelliFlo VF 3050 Set Parameters screen (page 58-65):** From these screens you can set up the pump parameters (filtering, priming, backwash, vacuum), assign a circuit name, assign up eight pump flows (GPM), or view the current pump status

IntelliFlo main pump screen (assign pump type, circuit, address)

From these screens you can assign the pump type, circuit name and address for each pump.

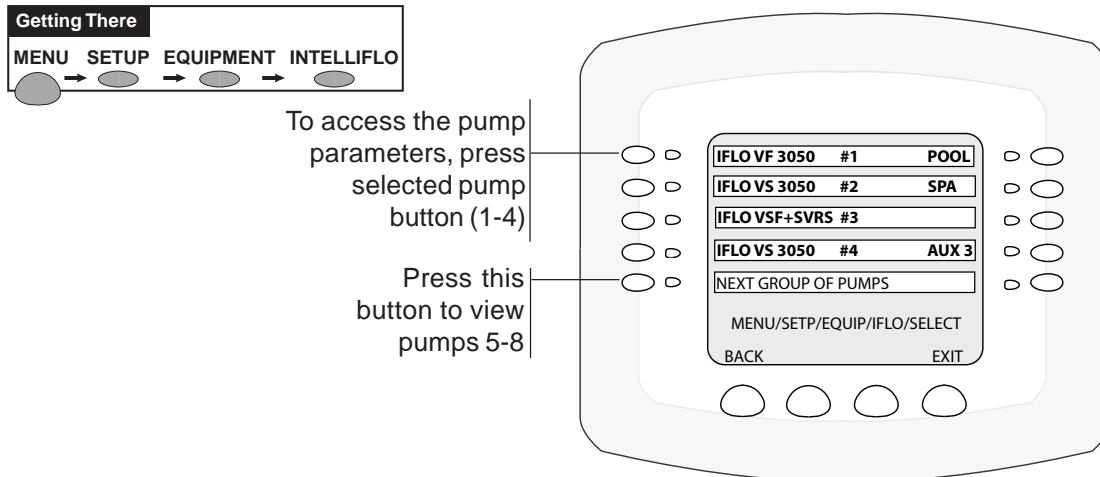

NOTE: INTELLIFLO AND CLEANER INTERLOCK: In order to safeguard the IntelliFlo pump and other equipment such as a pressure side cleaner booster pump, IntelliTouch monitors the main pump (if it is an IntelliFlo). If the pump stops, IntelliTouch will delay the cleaner function. This may take as much as 30 seconds. IntelliTouch will hold the cleaner off until the pump is running again. When the pump is running again IntelliTouch will restart the cleaner delay, as if it was just starting to insure water in the plumbing. IntelliTouch requires a bit more delay since the circulation pump may be on any address, e.g. #5, if there are four IntelliFlo VS pumps at 1 -4, and a VF at #5. So by default no pump is assigned. When you go into the menu "Circuit Functions" (see page 39, Menu>Setup>Advanced>Circuit Functions), if you assign a circuit as "Master Cleaner" an extra line will appear at the bottom of the screen. You can then select NONE if you don't have or want an IntelliFlo interlocked, or numbers 1 - 8 to identify the main circulation pump.

NOTE: INTELLIFLO "FREEZE" PROTECTION - If the IntelliFlo pump is on due to a freeze condition (not switch on from a relay circuit state), and if a freeze speed/flow is set in IntelliTouch, this setting takes priority even if the previous setting is lower than the default circuit speed. If no "freeze" protection is set, the pump will be forced **on** at the default circuit speed/flow. Any programmed or manual operation that actually switches on a circuit, will cause the pump to run at that speed if it is higher.

NOTE: INTELLIFLO IN "SERVICE MODE" - The IntelliFlo pump will STOP when IntelliTouch is in 'Service' mode. The pump will not stop if the communication cable is not connected or due to the pump's firmware.

NOTE: INTELLIFLO VF PUMPS - If the IntelliFlo VF pump is just starting (requiring a prime) and SOLAR is available, solar will be delayed for five (5) minutes to allow the pump to prime. This only applies for IntelliFlo pump(s) assigned as to a "pool" pump.

IntelliFlo VF 3050 pump setup

IntelliFlo Set Parameters screens

From these screens you can assign a circuit name, set up the pump filtering, priming, backwash, vacuum features, assign up eight pump flows (GPM), or view the current pump status.

Assign or change a pump circuit name

To assign a pump circuit:

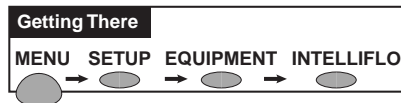

1. From the main pump screen, press the left side button next to the selected IntelliFlo pump. The current circuit for the pump is displayed on the main pump screen.
2. On the next screen, press the right side button next to **NONE**. If you have already assigned a circuit the current circuit name is displayed.

Note: The assigned circuits for the IntelliFlo pumps displayed on this screen are tied to the IntelliFlo background “Filtering Parameters” (see page 59), which includes programmed run times, turnovers, etc. This is also the circuit which all of the “Set Parameters” are linked to.

3. To assign a circuit name, press the **PREV** or **NEXT** lower button to select a circuit name for the pump. The selected circuit name must also be assigned a circuit function. For details about assigning a circuit function and a feature circuit, see pages 39 and 76.

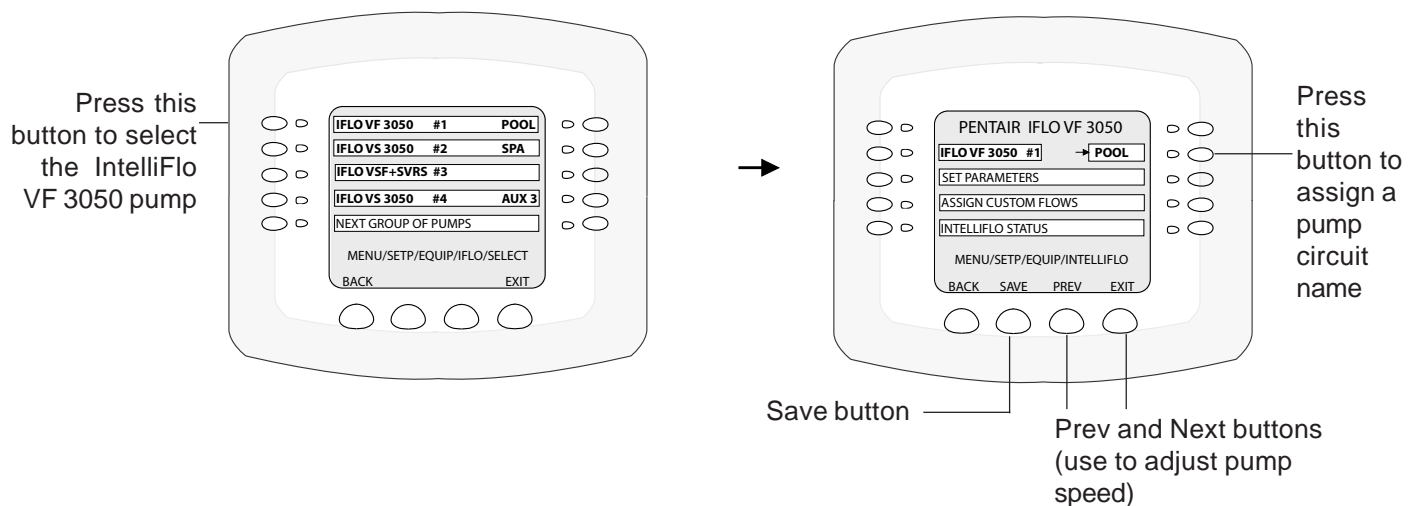

4. Press the lower **SAVE** button to save the setting. The main Equipment screen is displayed. Press the button next to **INTELLIFLO**. The main pump screen displays IntelliFlo #2 with the assigned circuit name. Select another IntelliFlo pump and repeat step 3 to assign a circuit name.
5. When finished, press the **BACK** button to return to the Equipment screen.

IntelliFlo VF 3050 pump setup (Continued)

Filtering parameters

The filtering parameters (pool size, turns per day) allows IntelliFlo to calculate the required flow rate which controls the motor speed to keep a constant flow. You can set up to eight turns per day. It is recommended that one turn per day for energy conservation be performed for most common residential pools. The “Manual Filter” option allows you to set the GPM to clean the filter by performing a “Backwash” cycle (see page 61).

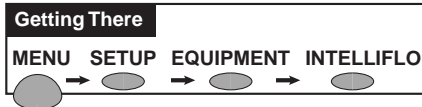

To set filtering parameters:

1. From the main pump screen, press the left side button next to the select IntelliFlo pump.
2. On the next screen, press the left side button next to **SET PARAMETERS** then on the following screen select **FILTERING PARAMETERS**.

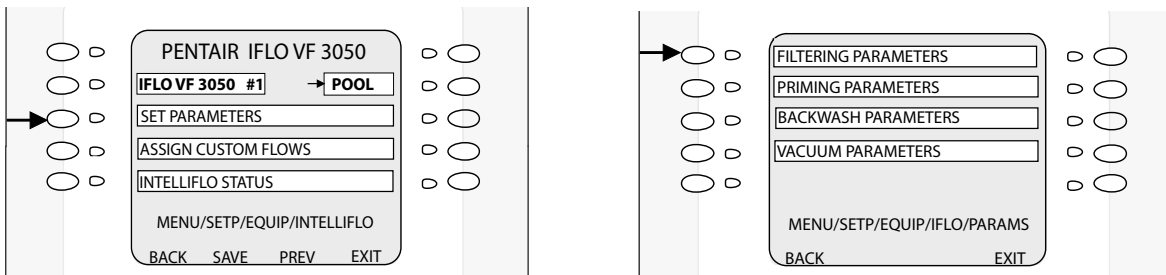

3. To adjust one of the parameters, use the top right button to increase and the top left button to decrease the parameter value.

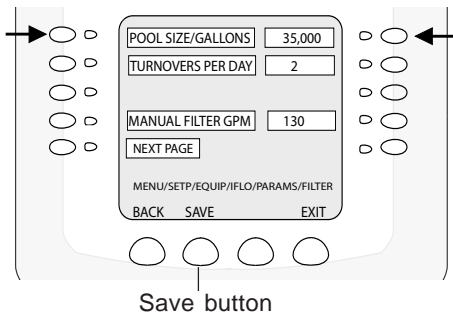

4. When finished, press the lower **SAVE** button to save the setting. The previous pump parameters screen is displayed. To modify another parameter select a feature from the parameter list. To exit, press the **EXIT** button to return to the Equipment screen.

Description	Value
<p>Pool Size/Gallons The pool size value is expressed as 1000's of gallons (Kgal). Enter from 1 to 1000 Kgal for the pool volume. The volume number can be a close estimate, although the more accurate the better the turns will be done when employing filter mode. Filter mode uses this value in coordination with the parameters from Filter mode to sustain turn rates, flows, and times.</p>	0-255
<p>Turnovers per day You can set up to up to eight turns per day. It is recommended to set one turn per day for energy conservation for most common residential pools. Also, refer to your sanitizer recommendation for additional information.</p>	1-8
<p>Manual Filter GPM (Default is 30 GPM) Manual Filter sets the flow at which the pump will run if it is turned on manually. The IntelliFlo pump will only run in the 'Filter' mode during the programmed times. For example, if the pump is programmed (start/stop times) for the pool circuit to run from 8:00 AM to 4:00 PM everyday. This program or programs are used by IntelliFlo to calculate at what speed it must run given those 'ON' times to achieve the turnover(s) for that sized pool for the basic filter mode.</p>	15-130

IntelliFlo VF 3050 pump setup (Continued)

Priming parameters

To “prime” a pump means filling the pump and suction pipe with water. This process evacuates the air from all the suction lines and the pump. It may take several minutes to prime depending on the depth of water, pipe size and length. It is easier to prime a pump if you allow all the air to escape from the pump and pipes. The water cannot enter unless the air can escape. Pumps do not hold prime, the pool piping system has that task. Priming is a function used every time the motor is started with a flow as reference. The “Priming Flow” function ensures the proper operation of the pump. The “System Priming Time” function ensures proper operation of the whole pool system. When the pump is priming, the control panel LCD displays “Priming” and then for a moment displays “Primed” when priming is complete.

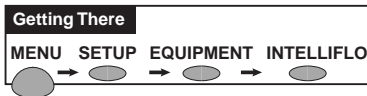

To set the priming parameters:

1. From the main pump screen, press the left side button next to the select IntelliFlo pump.
2. On the next screen, press the left side button next to **SET PARAMETERS** then on the following screen select **PRIMING PARAMETERS**.
3. To adjust one of the parameters, use the right button to increase and the left button to decrease the parameter value.
4. When finished, press the lower **SAVE** button to save the setting. The previous pump parameters screen is displayed. To modify another parameter select a feature from the parameter list. To exit, press the **EXIT** button to return to the Equipment screen.

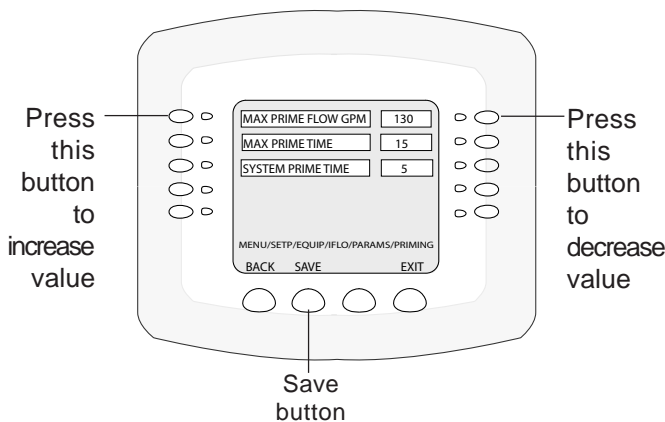
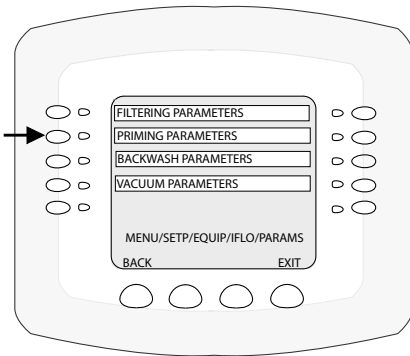

Description	Value
Max Prime Flow GPM - (Default is 55 GPM) Every time the pump starts this parameter will negotiate the maximum flow of the pump. If the flow is too high, equipment damage can occur. If the flow is too low the pump will not prime. This “flow” is system dependent and may require adjustment. The pump will never flow more than this parameter is set to, however, it is common for the pump to ramp up and down quickly while priming. Always try to keep this flow as low as possible for cost savings and safety.	60-130 GPM
Max Prime Time - (Default is 15 min.) Use this parameter to set the time that you want IntelliFlo try and prime before it reports an error. Remember that the IntelliFlo will attain prime every time it starts and goes through this cycle. The IntelliFlo mechanical seal can withstand about 15 minutes before severe damage occurs. The lower the time the quicker you will get a priming error if the system is difficult to prime. A well plumbed pool without having the strainer removed should prime in less than 30 seconds. If the strainer has been removed for cleaning and a substantial amount of air is in the system it should prime in about 60 to 90 seconds on the average, however, all systems will be different.	1-15 minutes
System Prime Time - (Default is 0 min.) Remember that the average unit will prime in a short period of time because the IntelliFlo has the ability to monitor itself to make sure it is primed. “System Prime Time” is for systems that require high flows that priming flow can provide but it is deemed that more time is needed to fully relieve all the air. The builder can program a pre determined amount of time, up to 5 minutes, to aid in relieving the air from difficult filters or complex vertical plumbing. The “System PrimeTime” should only be used where large air traps become problems within the system. The display will inform the user when this is engaged and when it is finished during the priming cycle at each start up cycle.	0-5 minutes

IntelliFlo VF 3050 pump setup (Continued)

Backwash parameters

When the pump detects that the filter differential pressure (10 PSI difference) has increased and is now at the “Clean Filter” pressure, IntelliTouch displays an alert message. This means that the filter must be cleaned (backwashed) to reduce the pressure. To do this, the pump must be stopped and the IntelliTouch outdoor control panel must be in “Service” mode (press the Auto button and select “Service” mode. To start the backwash flow operation, press the Start/Stop button on IntelliFlo, then press the Backwash button. The pump will run the preset cycle time and preset flow GPM). The flow will be adjustable to accommodate the specific filter backwash flow requirement. After the backwash cycle is finished, the “Rinse” cycle with the preset duration time will be executed. After these cycles have been completed or if the Start/Stop button is pressed to stop the process, the filter status will be recalculated and the zero-pressure measured when Filter mode is operated again.

When using cartridge filters the backwash cycle must be performed when cleaning or replacing filters. This helps the IntelliFlo reset its zero head pressure level. If you are charging a DE system, charge the system first during a normal running cycle. After the filter is charged, run the pump in backwash mode with the filter valve in the filter position to reset the % clean filter status. Then run the pump in filter mode.

Note: IntelliFlo will ramp up to full speed if necessary to achieve the commanded flow. Be sure that the system can withstand the resultant pressures.

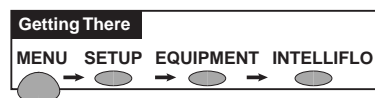

To set the backwash parameters:

1. From the main pump screen, press the left side button next “INTELLIFLO”.
2. On the next screen, press the left side button next to **SET PARAMETERS** then on the following screen select **BACKWASH PARAMETERS**.
3. To adjust each of the parameter values, use the right button to increase and the left button to decrease the value.
4. When finished, press the lower **SAVE** button to save the setting. The previous pump parameters screen is displayed. To modify another parameter select a feature from the parameter list. To exit, press the **EXIT** button to return to the Equipment screen.

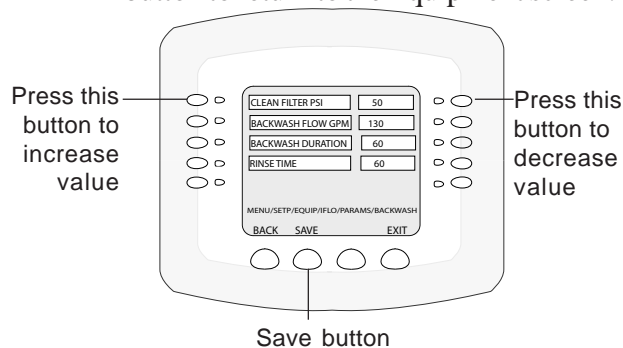

Description	Value
Clean Filter PSI - (Default is 14 PSI) The average PSI setting is between 10 PSI and 20 PSI for most pools and filters. The entered PSI value splits the percentage meter for the filter. When the "clean filter" value is reached, IntelliTouch displays an alert message and the pump stops monitoring flow rates and starts managing pressure. The value represents the change in pressure over time from start up (system clean) to present day (system getting dirty). The changes can come from anywhere in the system, for example clogged skimmers or pots in pumps. Setting this parameter at a lower level will cause the alert message to come up sooner and you will have to clean your filter (cartridge) or backwash your filter (sand or DE) sooner.	1-50 PSI
Backwash Flow GPM - (Default is 60 PSI)	15-130 GPM
Backwash Duration - (Default is 5 minutes)	1-60 minutes
Rinse Time - (Default is 1minute)	1-60 minutes

IntelliFlo VF 3050 pump setup (Continued)

Vacuum parameters

Use the Vacuum mode to clean the pool manually. To operate the pump in Vacuum mode, place the IntelliTouch outdoor control panel in “Service Mode,” and stop the IntelliFlo pump. The pool service person can then press the Vacuum button on the IntelliFlo pump. The pump would operate at the preset Vacuum parameters, then the blockage alert parameter would be cleared and the pump will stop. Vacuum mode only operates in flow control mode. Operating in Vacuum mode shuts off all of the pumps sensors. This mode is identical to IntelliFlo “Feature 1 and 2” except that you can manually start this mode using the Vacuum button. Safety considerations should be made when setting the Vacuum flow parameter.

CAUTION: Since vacuuming is manual work and the user will be at the pool, the “Blocked System” will be switched off, it is important not to use any kind of automatic cleaners, (such as Kreepy Krauly, etc.) with Vacuum mode.

To set the vacuum parameters:

1. From the main pump screen, press the left side button next to the select IntelliFlo pump.
2. On the next screen, press the left side button next to **SET PARAMETERS** then on the following screen select **VACUUM PARAMETERS**.
3. To adjust one of the parameters, use the right button to increase and the left button to decrease the parameter value.
4. When finished, press the lower **SAVE** button to save the setting. The previous pump parameters screen is displayed. To modify another parameter select a feature from the parameter list. To exit, press the **EXIT** button to return to the Equipment screen.

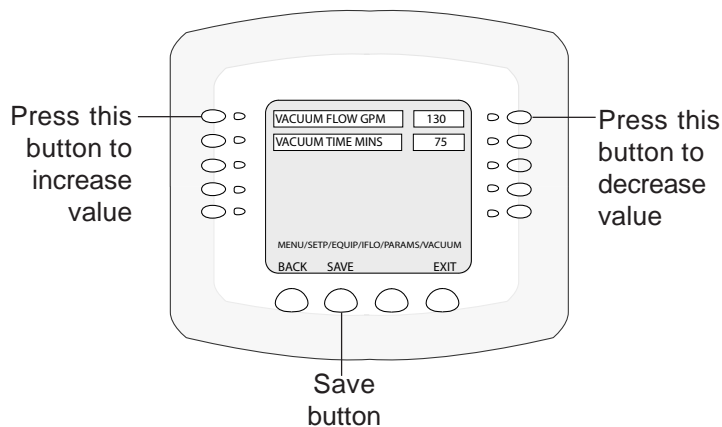

Description	Value
Vacuum Flow GPM (50 GPM default) This setting sets the GPM that the pool vacuum will use.	15-130 GPM
Vacuum Time Mins. (10 minutes default) This parameter can be set from 1 to 600 minutes. The typical setting is 10 minutes. This setting sets the amount of time you wish to run the pool vacuum.	1-600 minutes (10 hours)

IntelliFlo VF 3050 pump setup (Continued)

Assign custom flows

From the Assign Custom Flows screen you can assign different (normally higher) flows to circuits/features. For example you can set your SPA to run at 80 GPM. This way when you switch to spa mode, the pump goes from the calculated filter rate of about 28 GPM to 80 GPM while you use the spa. You have a waterfall, and require 60 GPM when it's switched on.

To assign a specific flow to a circuit/feature:

1. From the main pump screen, press the left side button next to the select IntelliFlo pump.
2. On the next screen, press the left side button next to **ASSIGN CUSTOM FLOWS**.
3. First assign a circuit name. Press the left side button for the selected circuit. Use the **PREV** and **NEXT** button to set the circuit. Then press the right side button to set the flow rate in GPM. The selected circuit/feature must also be assigned a circuit function/feature. For details about assigning a circuit function and feature circuit, see page 39 and 79.
4. When finished, press the lower **SAVE** button to save the setting. The previous pump parameters screen is displayed. To modify another parameter select a feature from the parameter list. To exit, press the **EXIT** button to return to the Equipment screen.

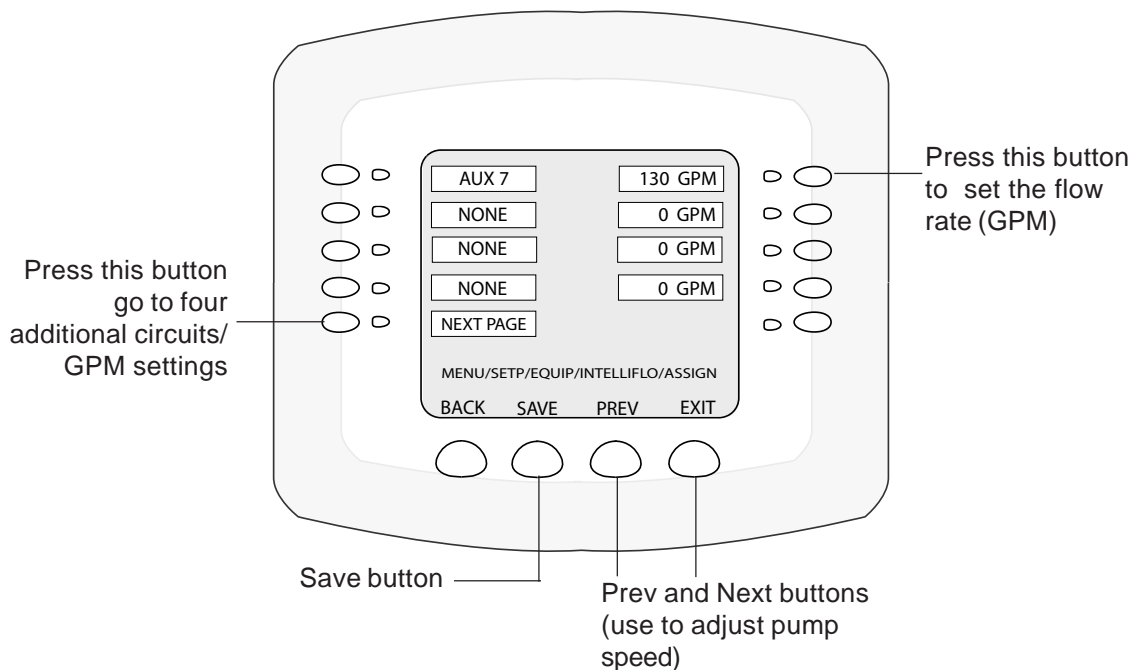

IntelliFlo VF 3050 pump setup (Continued)

IntelliFlo VF 3050 status screen

To view the current pump status:

1. Press **MENU > SETUP > EQUIPMENT > INTELLIFLO >**. Press the left side button next to the IntelliFlo VF 3050 pump.
2. On the next screen, press the left side button next to **INTELLIFLO STATUS**.
3. To exit, press the **BACK** button to return to the previous screen or **EXIT** to return to the main screen.

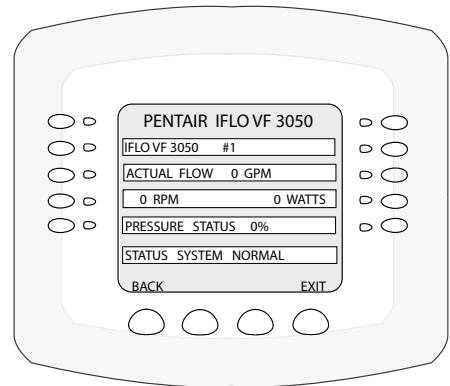

IntelliFlo VF 3050 Status screen description:

IntelliFlo VF 3050 #1:

Displays the IntelliFlo VF 3050 pump assignment number

Actual Flow 0 GPM

Displays the current flow rate for the pump in GPM

RPM:

Displays the current pump speed in RPM.

Watts:

To calculate a system's "Continuous Watts" use the following formula:

$\text{Amps} \times \text{Volts} \times \text{Power Factor} = \text{Continuous Watts}$

- 1 HP E+ WhisperFlo = 7.4 amps X (230 Volt) X .90 PF = 1532 watts

- 1 HP Max – E – Pro = 8.0 amps X (230 Volt) X .87 PF = 1600 watts

Once watts are computed, convert watts to kilowatts (kilo is 1000) and multiply this number by kilowatt/hour cost.

- 1 watt = .01 Kilowatt

- 100 watts = .1 Kilowatt

- 1000 watts = 1 Kilowatt

- 1 HP E+ WhisperFlo 1532 watts or 1.532 Kilowatt x \$.08 = \$.122 per hour

- 1 HP Max-E-Pro 1600 watts or 1.600 Kilowatt x \$.08 = \$.128 per hour

The IntelliFlo does not require calculation for continuous watts since it is displayed on the screen in all modes. Just simply take the watts published on the screen, convert to kilowatts, and multiply by the kilowatt hour. The formula is:

210 watts = .210 kilowatt X \$.08 = \$.016 per hour

Remember to also consider the amount of water moved for the cost incurred (Water to Wire Efficiency). The IntelliFlo cannot be matched in today's industry for flow versus continuous watts at any speed by any other pump in pool. The Filter mode and flow control further assists in cost saving by always allowing the pump to do the least amount of work at all times.

Pressure Status 0%:

Displays the current filter status in percentage value. The higher the percent value the nearer the filter will require a backwash and rinse cycle. See "Backwash Mode" on page 61 for more information.

Communication Status:

Displays the IntelliFlo operating status

IntelliFlo VS 3050 and VSF+SVRS Pump Setup

Setting up IntelliFlo VS 3050 and VSF+SVRS

IntelliFlo VS 3050 and VSF+SVRS pump speed can be remotely controlled an IntelliTouch system using a two-wire 50 foot RS-485 communication cable (P/N 350122) provided with the pump. The IntelliFlo VS 3050 and VSF +SVRS pump speed can be adjusted from the IntelliTouch Indoor Control Panel to run at any speed between 400 RPM to 3450 RPM with preset speeds of 750, 1500, 2350, and 3110 RPM. For more information refer to the IntelliFlo VS Installation and User’s Guide (P/N 357269) and the IntelliFlo and IntelliPro® VSF +SVRS Installation and User’s Guide (P/N 351420).

Assigning an IntelliFlo VS 3050 pump address

Before assigning a pump address in the IntelliTouch indoor control panel, first set the address **on the pump itself**. If there is only one pump, it is always seen as pump #1 by IntelliTouch. In this case you do not need to set the pump address. When using multiple IntelliFlo VS 3050 pumps with IntelliTouch you need to assign an address to each pump. The address can be set to #1, #2, #3, or #4. The address set at the pump must match the IntelliFlo pump number selected in the IntelliTouch indoor control panel.

***Note:** IntelliFlo pumps cannot be connected in series with other pumps.
Check valves must be used when a pump is used in parallel with other pumps.*

To assign an IntelliFlo VS 3050 pump address:

1. Be sure that the pump is powered on and the green power LED is on.
2. Press the **Stop** buttons to stop the pump.
3. Press and hold both the **Start and Stop** buttons until the red LED will starts flashing, then press one of the four speed buttons (1-4) to select which address to assign the pump. For example, if you are assigning the pump as pump #1, then press Speed button number 1.
4. Press and hold both the **Start and Stop** buttons to save the address. Repeat the process for the other pumps.

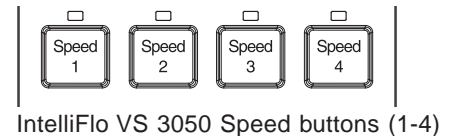

Assigning an IntelliFlo VSF +SVRS pump address

To assign an IntelliFlo VSF +SVRS pump address (1-16):

1. Press the **Start/Stop** button to stop the pump. Be sure that the green power LED is on and the pump is stopped.
2. Press the **Menu** button.
3. Press the **Up and Down** arrow buttons to scroll through the menu items. Press the **Select** button to access the “SETTINGS” menu.
4. Press the **Select** button to access the “PUMPADDRESS” setting.
5. Press the **Select** button to change the current pump address (1-16).
6. To enter the new address number, press the **Left and Right** arrows to select which digit to modify, then use the **Up and Down** arrows to change the selected digit.
7. Press the **Enter** button to save the changes. To cancel any changes, press the **Escape** button to exit edit mode without saving.

NOTE: INTELLIFLO “FREEZE” PROTECTION - If the IntelliFlo pump is on due to a freeze condition (not switch on from a relay circuit), and if a freeze speed is set in IntelliTouch, this setting takes priority even if the previous setting is lower than the default circuit speed. If no “freeze” protection is set, the pump will be forced on at the default circuit speed. Any programmed or manual operation that actually switches on a circuit, will cause the pump to run at that speed if it is higher.

NOTE: INTELLIFLO IN “SERVICE MODE” - IntelliFlo pumps will STOP when IntelliTouch is in ‘Service’ mode.

IntelliFlo VS 3050 and VSF+SVRS Pump Setup (Continued)

Setting up IntelliFlo VS 3050 and VSF +SVRS pump from the Equipment Screen

After you have assigned the pump address on the IntelliFlo VS 3050 and VSF +SVRS pump (see previous page), assign the pump type being used and the pump address in the IntelliTouch “Equipment” screen. When using a single IntelliFlo VS 3050 or VSF +SVRS pump for remote control with IntelliTouch, the default address is always pump #1. When using multiple IntelliFlo VS 3050 and VSF +SVRS pumps with IntelliTouch assign an address to each pump. For IntelliFlo VS 3050 set the address to #1, #2, #3 or #4. For IntelliFlo VSF +SVRS set the address from #1-#8. The address set at the pump must match the IntelliFlo pump number selected in the “Equipment” screen. This is also where you select the pump type being used and its address (IntelliFlo VF 3050 #1, IntelliFlo VS 3050 #2, IntelliFlo VSF +SVRS #3 etc.).



To select the pump type (IntelliFlo VS 3050 and IntelliFlo VSF +SVRS) and it's address:

1. Press one of the left side buttons next to the IntelliFlo pump type and number (address) that you wish to change. **Note: IntelliFlo VS 3050 pumps can be assigned to address #1 through #4. IntelliFlo VSF +SVRS 3050 pumps can be assigned to address #1 through #16.**

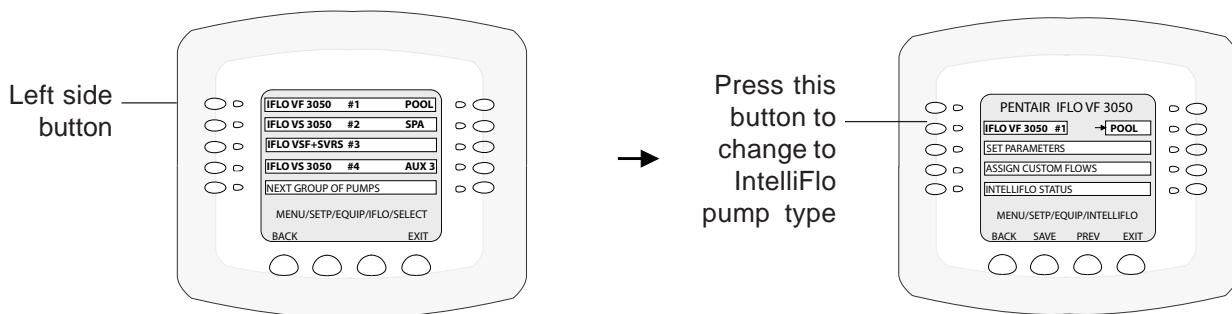

2. Press the left side button again next to the IntelliFlo pump selected in step 1. The next screen message indicates that you can change the pump type displayed or no change to the selected pump type. Pressing the lower “NO” button returns you to the previous screen. Pressing the same selected pump type again from this screen displays the next pump type. This way can scroll through the three pump types available. The three pump types to choose from are; **IFLO VS3050, IFLO VF 3050 and IFLO VSF +SVRS.**
3. Press the lower right “YES” button to accept the pump type selection or press the ”NO” button for no change. On the next screen, press the **Save** button to save the setting. The main Equipment screen is displayed. Press the button next to **INTELLIFLO**. The main pump screen displays IntelliFlo pump type assigned to pump #1. To set another IntelliFlo 4 pump, repeat steps 1-3.

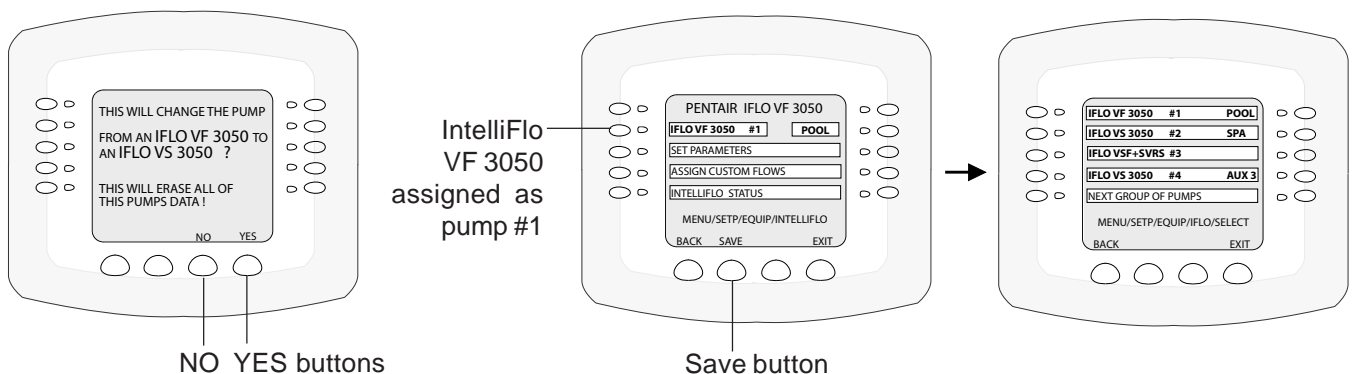

IntelliFlo VS 3050 and VSF +SVRS Pump Setup (Continued)

Priming Parameters (IntelliFlo VS 3050)

The IntelliFlo VS 3050 pump priming parameters allow the priming speed and duration length/time selection. The priming speed can be set from 400 RPM to 3450 RPM. The duration time can be set from 0 to 5 minutes, in one minute increments. **Note:** *If the IntelliFlo pump is powered on, and a priming parameter is set to a time greater than 0 minutes, the priming speed will be used from that period (assuming the priming speed is greater than the speed being requested).*

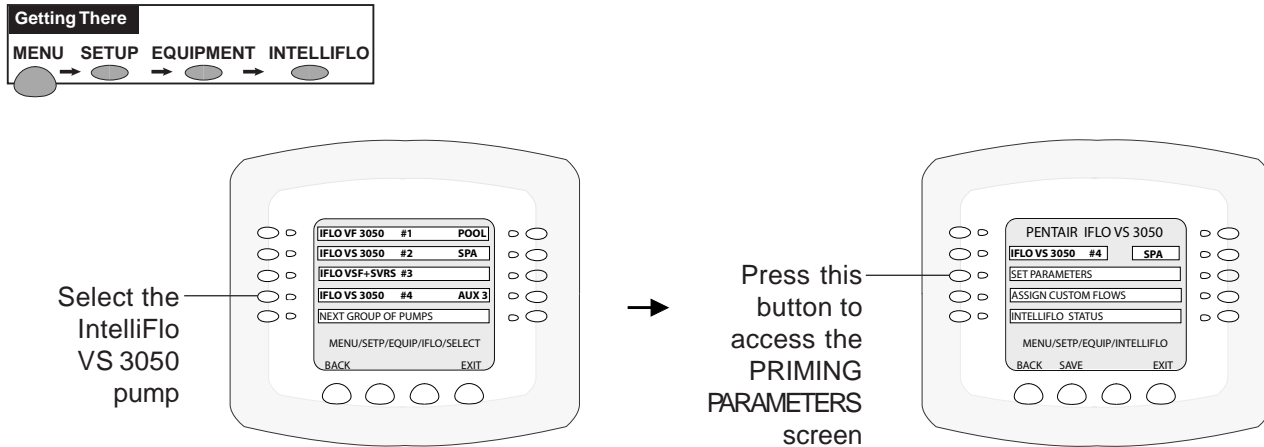

To set the IntelliFlo VS 3050 priming parameters:

1. From the main pump screen, press the left side button next to the IntelliFlo VS 3050 pump. Note: IntelliFlo VS 3050 pump can only be assigned as pump #1, #2, #3, or #4.
2. On the next screen, press the left side button next to “PRIMING PARAMETERS.”
3. From the next screen you can set the pump priming time and speed:

Set priming time: Press the top left or right side button to set the priming time from 0 to 5 minutes, in one minute increments.

Set priming speed (RPM): Press the priming speed left or right side button to set the pump priming speed from 400 RPM to 3450 RPM.

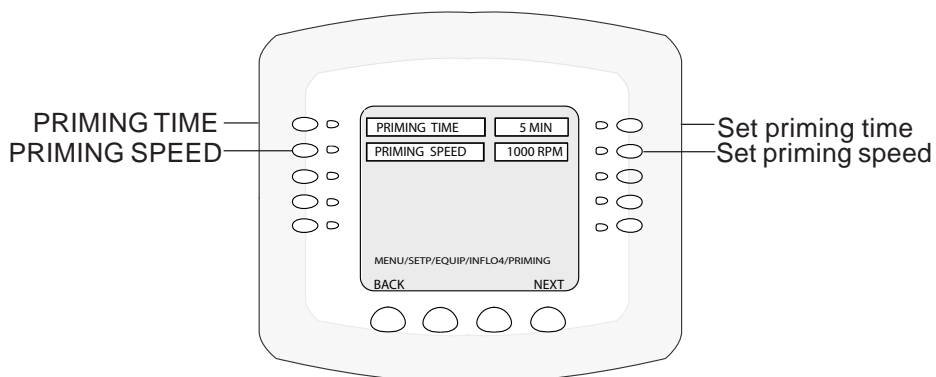

4. Press the lower **SAVE** button to save the settings.
5. Press the **EXIT** button to return to the Equipment screen. Press EXIT again to return to the main screen.

IntelliFlo VS 3050 and VSF+SVRS Pump Setup (Continued)

Assign custom speeds (RPM) IntelliFlo VS 3050 pump

Each Intelliflo VS 3050 pump can have a maximum of eight assigned circuits with eight preset pump speeds (RPM). The speeds can be set from 400 RPM to 3450 RPM.

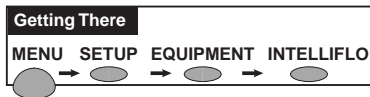

To set the IntelliFlo VS 3050 pump speed to an assigned circuit name:

1. From the main pump screen, press the left side button next to the selected IntelliFlo VS 3050 pump.
Note: An IntelliFlo VS 3050 pump can only be assigned as pump #1, #2, #3, or #4.
2. On the next screen, press the left side button next to ASSIGN CUSTOM SPEEDS.

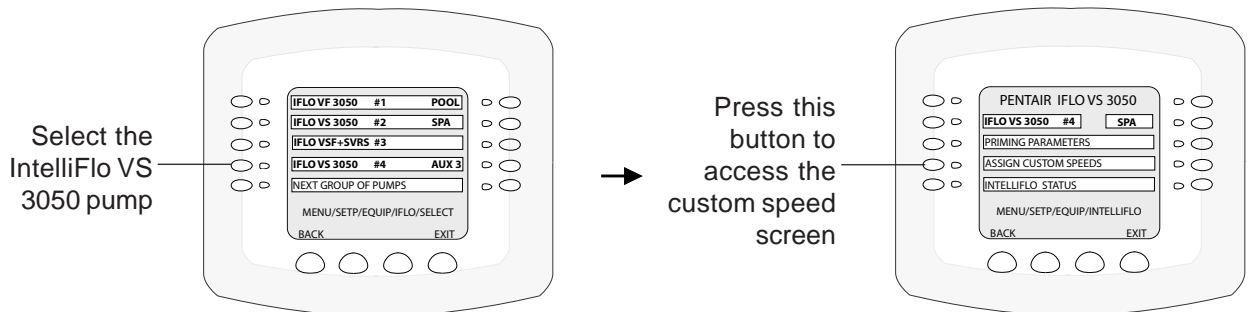

3. From the next screen you can assign a circuit name and set the pump speed. To assign a circuit name, press one of the left side buttons next to “NONE.” Press the PREV or NEXT lower button to select a circuit name for the pump. The selected circuit name must also be assigned a circuit function. For details about assigning a circuit function, see page 39. Press the corresponding RPM button on the right side to set the speed. Use the DOWN and UP lower buttons to adjust the speed from 400 RPM to 3450 RPM.

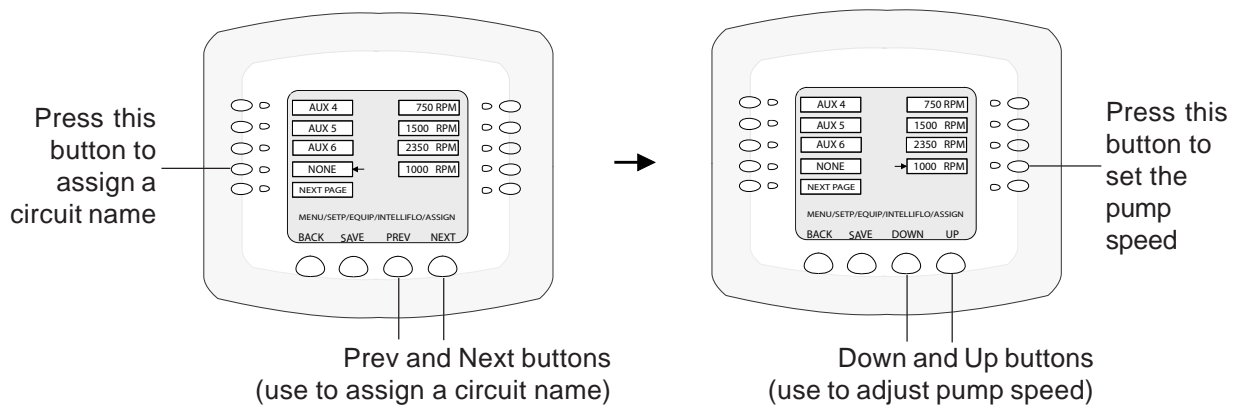

4. Press the lower **SAVE** button to save the circuit and speed setting. To set another circuit and pump speed, press the button next to **ASSIGN CUSTOM SPEEDS** to access the circuit and speed setup screen. If you need additional pump speed circuits, press the button next to **NEXT PAGE** to access an additional four circuits, then repeat step 3.
5. When finished, press the **BACK** button to return to the Equipment screen.

IntelliFlo VS 3050 and VSF+SVRS Pump Setup (Continued)

Assign custom speeds (RPM) or flow rates (GPM) - IntelliFlo VSF+SVRS pump only

Each Intelliflo VSF+SVRS pump can have a maximum of eight assigned circuits with eight preset pump speeds (400 - 3450 RPM) or flow rates (15 - 130 GPM).

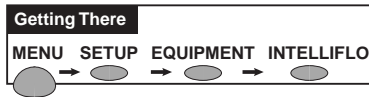

To assign a circuit name to the IntelliFlo VSF+SVRS pump:

1. From the main pump screen, press the left side button next to the selected IFLO VSF+SVRS pump.
Note: The IntelliFlo VSF+SVRS pump can assigned as pump #1 - #8.
2. On the next screen, press the left side button next to ASSIGN CUSTOM SPEEDS/FLOWS.

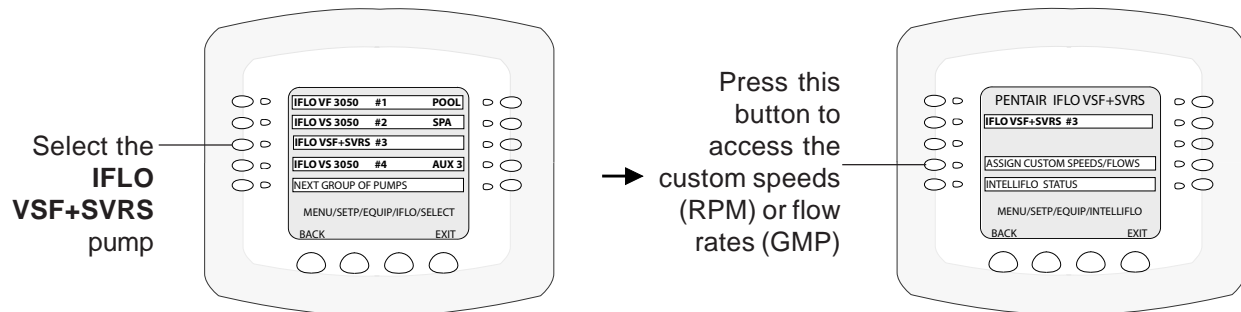

3. From the next screen you can assign a circuit name and set the pump speed or flow rate.
Assign a pump circuit name: Press one of the left side buttons next to NONE. Press the PREV or NEXT lower button to select a circuit name for the pump. The selected circuit name must also be assigned a circuit function. For details about assigning a circuit function, see page 39.
4. Press the lower **SAVE** button to save the circuit name and return to the previous screen. To set another pump circuit, press the button next to ASSIGN CUSTOM SPEEDS/FLOWS to access the circuit and speed setup screen. Note: To display the additional four pump circuits, press the button next to NEXT PAGE.

proceed to next step..

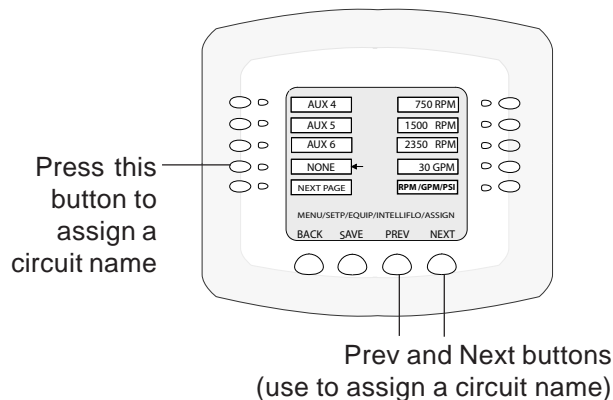

IntelliFlo VS 3050 and VSF+SVRS Pump Setup (Continued)

Assign custom speeds (RPM) or flow rates (GPM) - IntelliFlo VSF+SVRS pump only

To set the IntelliFlo VSF+SVRS pump speed or flow rate to an assigned circuit name:

5. **Adjust pump speed (RPM) or flow rate (GPM):**

Press the ASSIGN CUSTOM SPEEDS/FLOWS button to access the pump circuit and speed screen. Press the right side button next to the pump speed (RPM) or flow rate (GPM). Use the DOWN and UP lower buttons to adjust the speed (400-3450 RPM) or flow rate (15-130 GPM).

6. Press the **SAVE** button to save the setting and return to the previous screen.

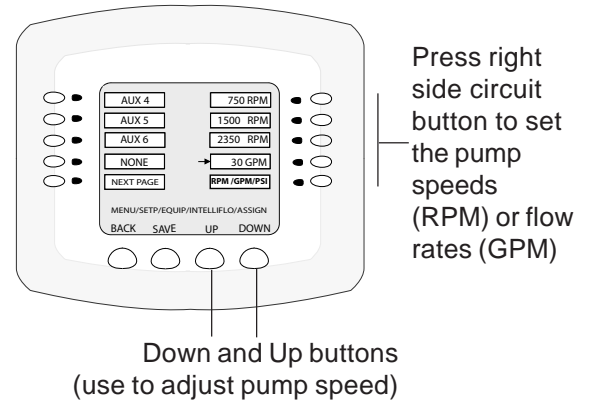

7. **Display RPM or GPM:** Pump speed can be defined on the screen as RPM or GPM (useful to determine the daily pool filter cycle).

Toggle between RPM and GPM: To change the display from RPM to GPM, press the ASSIGN CUSTOM SPEEDS/FLOWS button to access the pump circuit and speed screen. Press the button next to a circuit that displays RPM (e.g. 1110 RPM) (an indicator arrow is displayed), then press the button next to **RPM/GPM/PSI** (the display shows the GPM equivalent (e.g. 30 GPM)).

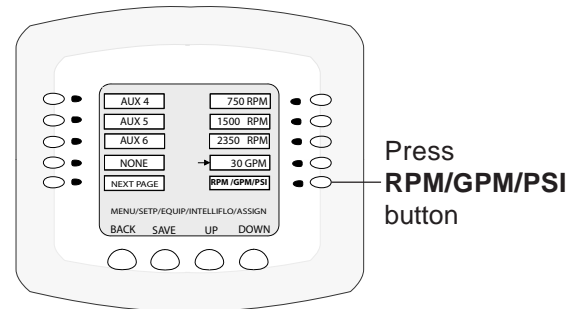

8. **Adjusting the MAXIMUM PRESSURE SETTINGS (PSI) when using GPM:** Press the right side button next to the current PSI setting. Press the DOWN and UP buttons to adjust the PSI setting. Press the **SAVE** button to save the setting.

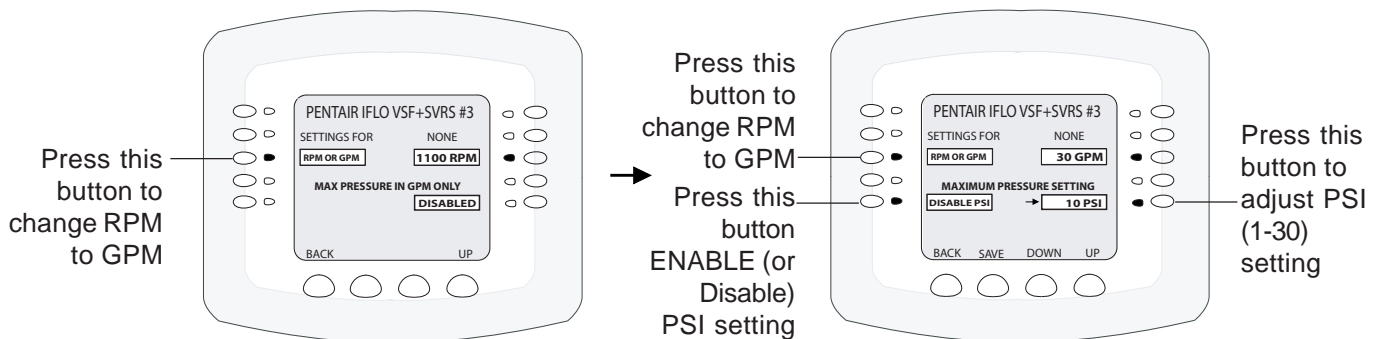

9. When finished, press the **BACK** button three times to return to the Equipment screen.

IntelliFlo VS 3050 and VSF+SVRS Pump Setup (Continued)

IntelliFlo VS 3050 and IntelliFlo VSF+SVRS Status Screen

From this screen you can view the IntelliFlo status screen for current real-time pump operations. From this screen you can view the current speed (RPM), power usage (WATTS), and communication status for the pump.

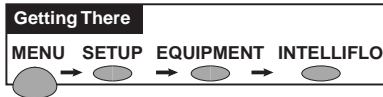

To access the IntelliFlo status screen:

1. From the main pump screen, press the left side button next to the IntelliFlo pump that you wish view the status for.
2. On the next screen, press the left side button next to INTELLIFLO STATUS to access the status screen. This screen displays the selected IntelliFlo pump and address number, current speed (RPM/GPM), power usage and communication status.

Select the IntelliFlo VS 3050 pump to view its current status

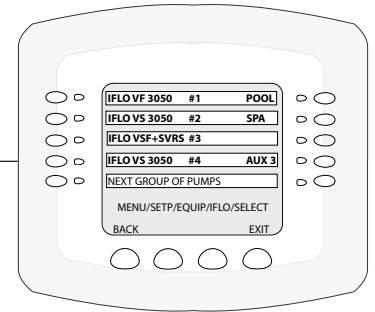

Press this button to access the INTELLIFLO STATUS screen

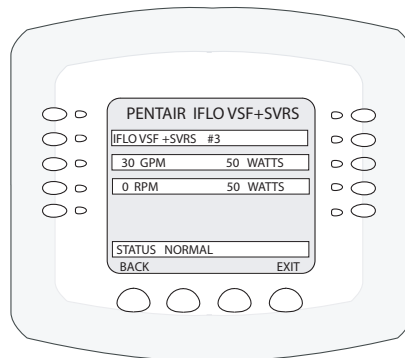
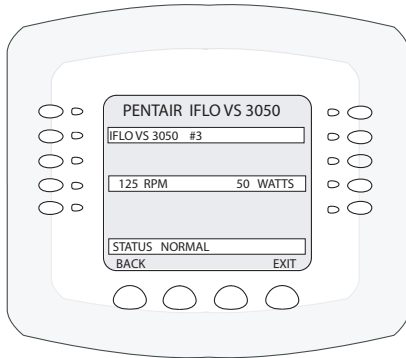
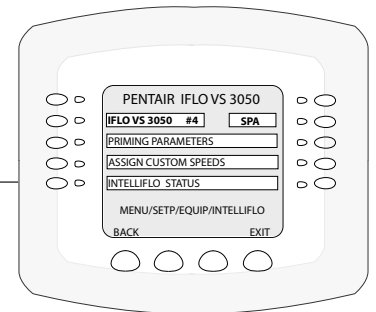

IntelliFlo VS 3050 status screen IntelliFlo VSF+SVRS status screen

IntelliFlo VS 3050 and IntelliFlo VSF+SVRS status screen description:

IntelliFlo VS 3050 #1: Displays the IntelliFlo VF 3050 (VSF+SVRS) pump assignment number

RPM: Displays the current flow rate for the pump in RPM. Note: For IntelliFlo VSF+SVRS pump, when in RPM mode GPM = 0.

Watts: To calculate a system's "Continuous Watts" use the following formula:

Amps X Volts X Power Factor = Continuous Watts

- 1 HP E+ WhisperFlo = 7.4 amps X (230 Volt) X .90 PF = 1532 watts

- 1 HP Max – E – Pro = 8.0 amps X (230 Volt) X .87 PF = 1600 watts

Once watts are computed, convert watts to kilowatts (kilo is 1000) and multiply this number by kilowatt/hour cost.

- 1 watt = .01 Kilowatt

- 100 watts = .1 Kilowatt

- 1000 watts = 1 Kilowatt

- 1 HP E+ WhisperFlo 1532 watts or 1.532 Kilowatt x \$.08 = \$.122 per hour

- 1 HP Max-E-Pro 1600 watts or 1.600 Kilowatt x \$.08 = \$.128 per hour

The IntelliFlo does not require calculation for continuous watts since it is displayed on the screen in all modes. Just simply take the watts published on the screen, convert to kilowatts, and multiply by the kilowatt hour. The formula is: 210 watts = .210 kilowatt X \$.08 = \$.016 per hour

Remember to also consider the amount of water moved for the cost incurred (Water to Wire Efficiency). The IntelliFlo cannot be matched in today's industry for flow versus continuous watts at any speed by any other pump in pool. The Filter mode and flow control further assists in cost saving by always allowing the pump to do the least amount of work at all times.

Communication Status: Displays the pump communication and operating status.

Setting up an UltraTemp Heat Pump

UltraTemp heat pump screen (HEAT PUMP COM)

From the HEATPUMPCOM screen you can view the current heat pump operation status, and set the unit to operate with for heating only, cooling only or both heating and cooling if the unit is reversible. Connection from the Pentair UltraTemp heat pump to the IntelliTouch system is via an RS-485 communication cable to a COM PORT on the IntelliTouch Personality circuit board. See page 112 for UltraTemp to IntelliTouch COM port wiring information. The UltraTemp heatpump must be set to default ADDRESS 1. One UltraTemp unit can be connected to an IntelliTouch system.

Operating UltraTemp

The UltraTemp heat pump is reversible, meaning it can heat or cool. When cooling is selected, an option heat control is displayed in the HEAT screen below the pool heat settings labeled as POOL MAX. This setting allows you to set the maximum heat temperature setting for the pool before the UltraTemp cooling begins.

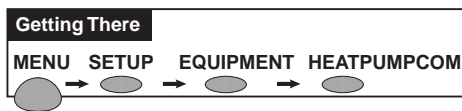

To access the UltraTemp heat pump communication screen:

1. From the **EQUIPMENT** screen, press the left side button next to **HEATPUMPCOM**.
2. On the next screen, press the left or right side button to set the heat pump options. To enable the heat pump, select YES for HEATPUMPCOM PRESENT, HEATPUMPCOM HEATING (use heating only), and HEATPUMPCOM COOLING (If the unit is reversible select YES to enable the cooling feature, or just cooling only).

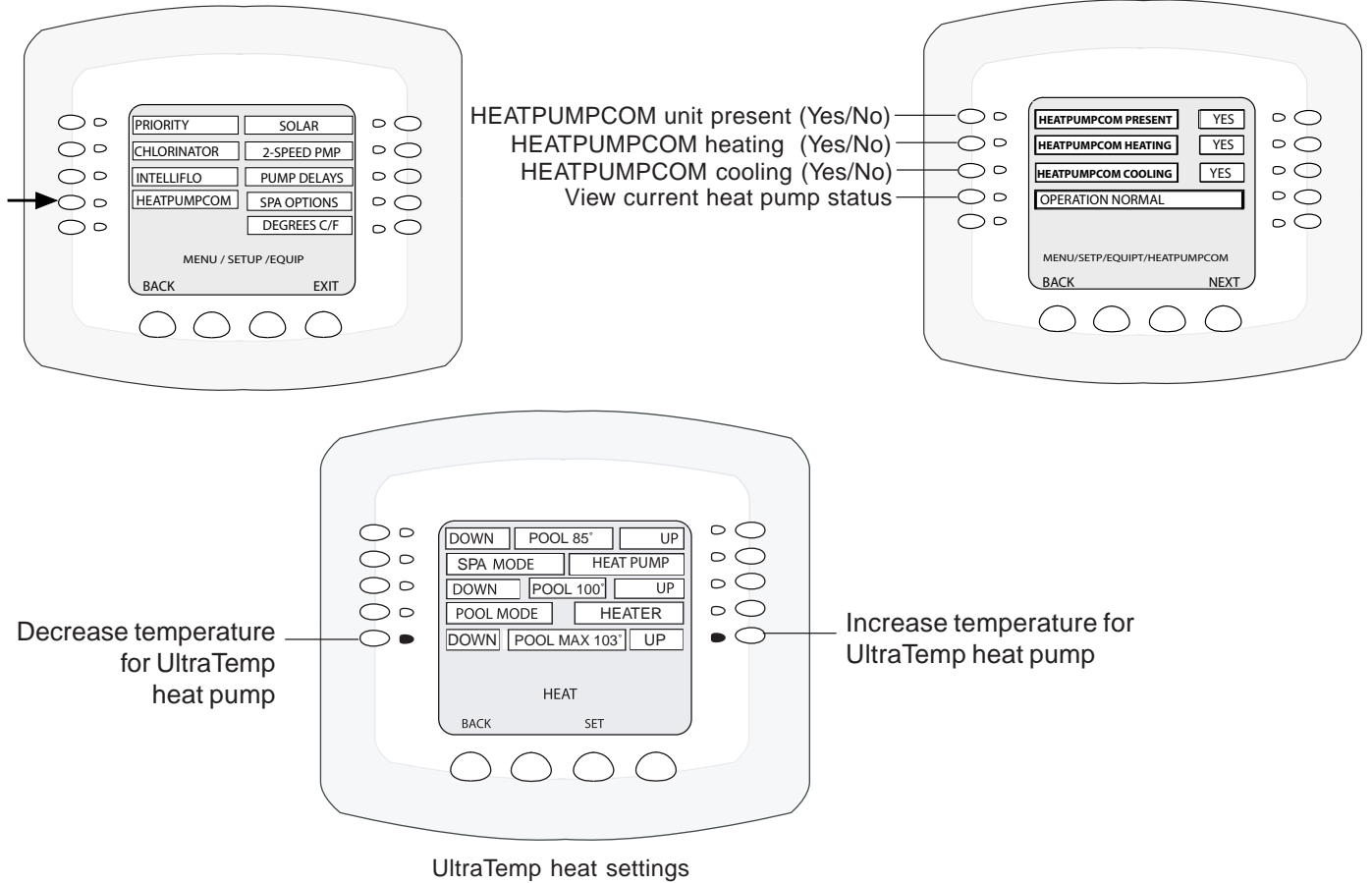

Setting up IntelliChem Water Chemistry Controller

IntelliChem screen

IntelliChem provides the IntelliTouch system with continual analysis of your swimming pool water sanitation and pH levels, providing real-time status information to dispense the proper amount of muriatic acid (pH reducer) and chlorine or bromine for the correct sanitization and pH balance. IntelliChem operates with or without a salt chlorine generator to provide a self-replenishing supply of chlorine generated from salt. For more information, refer to the IntelliChem Installation and User's Guide (P/N 521363). From the IntelliChem screens you can adjust the pH and Oxidation Reduction Potential (ORP) set point values to meet pool and spa chemistry standards for your pool. To access the IntelliChem screen:



The IntelliChem screen settings are displayed as follows:

PH/ORP Values: The current pH and ORP values display next to the set point settings.

pH Set: Displays the current pH set point value. The adjustable range is from 7 to 8 in increments of 0.1. The default pH set point value is 7.5. To adjust the pH set point, press the button next to pH Set.

ORP Set: Displays the current ORP set point value. The adjustable range is from 650 to 800 in increments of 10. The default ORP set point value is 700 (chlorine level of 3.0 ppm). The ORP set point is the value that IntelliChem will try to achieve based on the actual chlorine level (ppm). To adjust the ORP set point, press the button next to ORP Set.

ORP/PH TANK LEVEL: The current IntelliChem ORP and pH tank level are displayed. To adjust the gauge levels, press the button next to ORP TANK or PH TANK. Press the Down/Up buttons to set the chemical levels in the containers.

ALARMS: View the current IntelliChem ORP and pH alarms. IntelliChem automatically displays a screen message indicating the pH level has reached or exceeded the **HIGH (7.8) or LOW (6.8)** pH alarm level settings. IntelliChem will automatically set a high and low alarm for the pH level. The Delay time is the amount of time between the detected alarm condition and when IntelliChem displays the alarm message on the main screen. The Delay setting is adjusted in increments of 15 seconds.

Saturation Index/Menu: To access the Saturation Index screen, press the button next to SATURATION INDEX/MENU. The current Saturation Index value, water condition, water temperature and Total Dissolved Solids (TDS) are displayed. Press the button next to the following selections to adjust the levels/values: **Calcium Hardness:** Recommended range is 200-400 ppm. Levels should be tested weekly. **Cyanuric Acid:** Stabilizes chlorine in water from UV degradation. When using the IntelliChlor SCG, cyanuric acid level should be maintained between 50-80 ppm. **Total Alkalinity:** APSP's recommended ideal range for is 80 to 120 ppm for "gunite" and concrete pools and 125-170 ppm for painted, vinyl, and fiberglass pools. Test levels weekly and adjust according to your pool professional's recommendations.

Saturation Index: The saturation Index displays IDEAL (Optimum levels), CORROSIVE (pH too low) or SCALING (pH too high). For ideal Saturation Index levels and recommended pool chemistry, refer to the following values: **pH range: 7.2 to 7. ORP range: 650 to 750. Calcium Hardness: 200 - 500 ppm. Cyanuric Acid/Stabilizer: 30-50 ppm. Total Alkalinity: 80 to 120 ppm.**

NOTE: Use a Test Kit (with fresh testing reagents) to measure the pH, alkalinity and calcium hardness of the pool water. For greater accuracy, use the AcuCheck3 Test Kit to measure pH, chlorine ppm, and alkalinity levels (P/N 7450001100). "Balanced" water has proper levels of pH, Total Alkalinity and Calcium Hardness. This "balanced" water is neither corrosive or scaling. The pH level number (0-14 with 7.0 being neutral) is the scale of relative acidity or alkalinity. Be sure the pool chlorine level is balanced. Ideal free chlorine level should be between 1.0 - 3.0 parts per million (ppm). Use the online Langelier Saturation Index (LSI) calculator to diagnose the water balance in your pool or the IntelliChem built-in LSI calculator. Refer to: <http://www.pentairpool.com/pool-owner/resources/calculators/langelier/> - A Saturation Index value of 0 indicates the water is chemically in balance. If the Index is a minus (-) value, corrosive tendencies are indicated. If the Index is a plus (+) value, scale-forming tendencies are indicated. A Saturation Index value between +0.3 to -0.3 is considered satisfactory in a swimming pool.

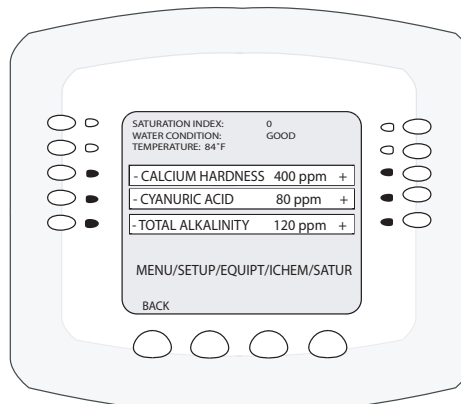
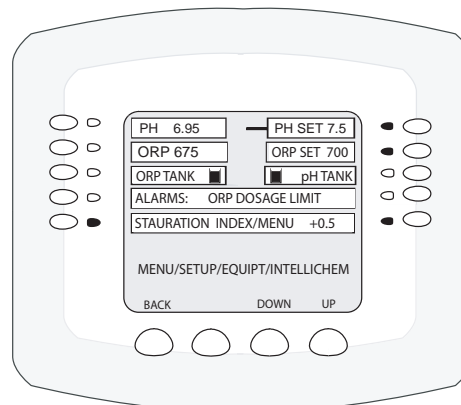
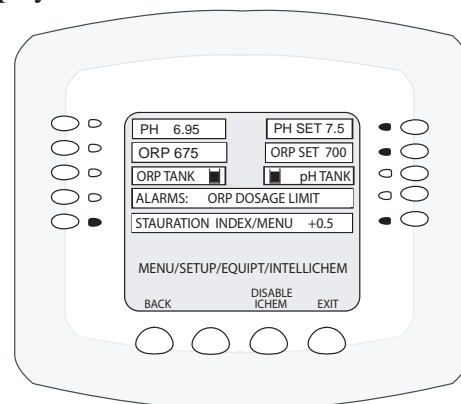

Setup Solar Equipment and Heat Pump Option

Setting up solar equipment

Note: If solar is set then the Valve A actuator will be dedicated to the solar valve actuator.

Setting the system to Heat pump will free Valve A for use on other valves.

Note: Use the "Temp Diff" button at the bottom of the screen to change solar start and stop temperatures differentials (same as the solar sensor(s) temperature).

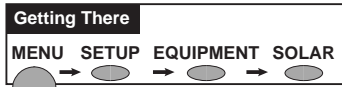

1. Press either the right or left side button next to the SOLAR selection to select YES or NO. The solar selections are:

Pool Solar Present: Is the pool using solar heat?

Solar is a Heat pump: Is a heat pump being used for solar heat?

Spa solar present: Is solar heat being used for the spa water?

Solar freeze protection: Enable freeze protection when using solar heat.

Nocturnal Cooling: Circulate water through the system to lower the temperature during the night hours. Set the temperature in the Heat menu.

Note: If a heat pump is being used instead of a solar heating system (see below), press the button next **Solar is a Heatpump** to **Yes**.

Note: For model i10+3D, press **YES** for each body of water with solar heating.

2. Press the **Save** button when finished. Press the **Exit** button to return to the main screen.

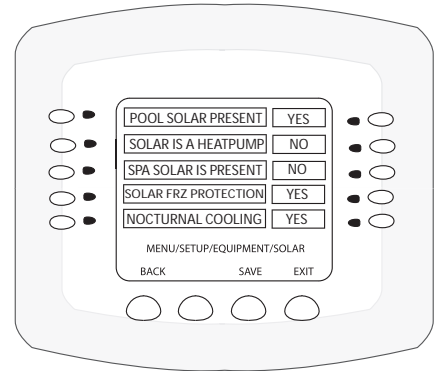

Setting up a heat pump and gas heater

If you are using IntelliTouch with a UltraTemp® heat pump (see previous page) and a natural gas heater, the heat pump should be installed first in line, then the gas heater. The heat pump will run until the ambient air temperature is approximately 50° F, at which point the heat pump will switch off and the heater will switch on and take over. The air temperature is detected by the solar temperature sensor located on the IntelliTouch load center. The air temperature is not adjustable.

To set up the UltraTemp heat pump see the previous page.

To adjust the pool and spa temperature settings from the HEAT screen, press the **HEAT** button at the bottom of the screen.



SPA MODE: Press the button next to SPA MODE) and select the heating mode (HEATPUMP/HEATER/OFF).

POOL MODE: Press the button next to POOL MODE to select the heating mode (HEATPUMP/HEATER/OFF).

Note: Select **H PUMP PREF.** - If a heat pump is in combination with other heating systems and you want to use the heat pump only when it is most effective.

Press the **Set** button to save the settings. Press the **Back** button to return to the main screen.

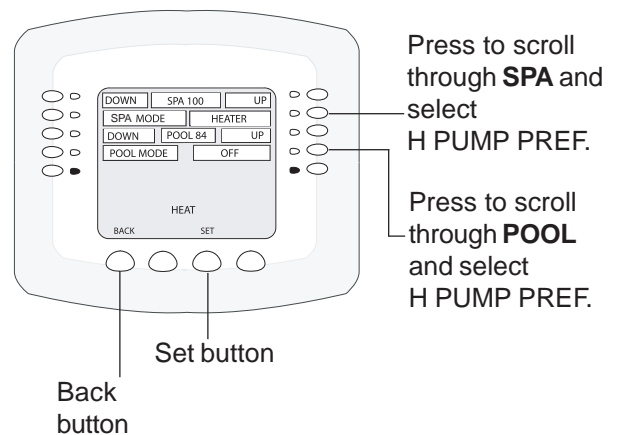

NOTE: INTELLIFLO VF PUMPS - If the IntelliFlo VF pump is just starting (requiring a prime) and SOLAR is available, solar will be delayed for five (5) minutes to allow the pump to prime. This only applies for IntelliFlo pump(s) assigned as a "pool" pump.

Setting up a 2-Speed Pump

Equipment circuits displayed on this screen will automatically switch a two speed filter pump to high speed when these circuits are switched on. For example, the filter pump will switch from low speed to high speed whenever the JETS or CLEANER circuit is switched on.

Go to the **2-Speed Pump** screen to select your choice of heat options to force the pump to high speed:

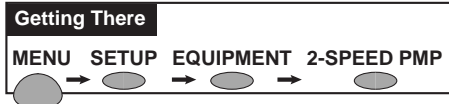

1. Press the button next to **None**. A small arrow is pointing to the select circuit name. “NONE” indicates that the pump circuit has not been selected.
2. Use the **Up** and **Down** buttons at the bottom of the screen to scroll through the previously assigned names to add another circuit for switching filter pump to high speed. After you have found the desired circuit. To add another circuit, repeat step 1, or Press the **Save** button. A “FEATURE” circuit can be used to switch the pump from low speed to high speed (see page 79).
3. Press the **Save** button.
4. Press the **Exit** button to return to the main screen.

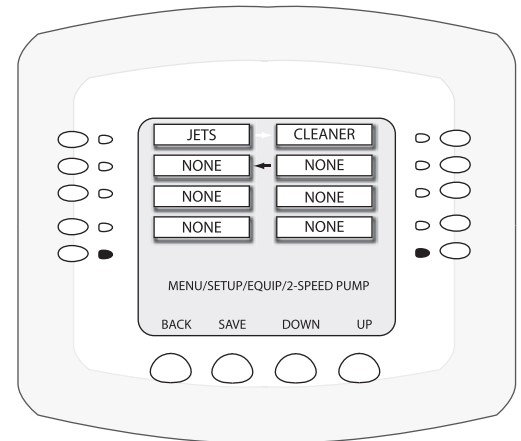

Note: With a dual equipment system i10+3D, the left column controls the spa pump and the right column controls the pool pump.

Master Spa/Pool (Heater Cool-Down) and Delays For Valves

Master Spa/Pool

This feature keeps the pump running for ten minutes after the heater is switched off to cool down the heaters header and heat exchanger. Some heater models require this cool down period or damage will occur. This is sometime referred to as the “Fireman Switch.” for example, If you are in the spa, and you switch it off. The IntelliTouch will return the valves to “Pool” mode position. If the pool is running a cycle, or the Fireman switch (Master Spa/Pool Delay) is enabled, colder water from the pool would be pumped into the spa as the valves turn. Note: If the pool is not running a cycle, and the fireman switch is not enabled, the pump stops and no pool water would be pumped into the spa as the valves turn back to pool.

Delay For Valves

This feature creates a 30 second PUMP OFF (forced) period anytime the valves rotate. Either from pool to spa, or spa to pool. When you switch the spa off, even if the pool is running a cycle or the fireman switch is enabled, it stops the pump for 30 seconds while the valves turn, so colder water from the pool will not enter the spa. This feature prevents cold water entering the spa when you start the spa, so less heating is needed. It also stops the pump when the system is changing from pool to spa or back again in Freeze mode.

Continue on next page.

Master Spa/Pool (Heater Cool-Down) and Delays For Valves (Continued)

Go to the **Pump Delays** screen.

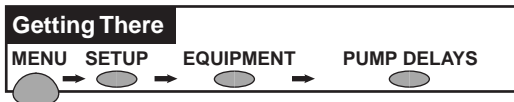

1. Press the button next to **Master Spa/Pool**. Press the left or right side button change the setting to **Yes**. *Note: Pentair Water Pool and Spa® heaters do not require this feature.*
2. Press the button next to **Delay For Valves**. Press the left or right side button change the setting to **Yes**.
3. Press the **Save** button.
4. Press the **Exit** button to return to the main screen.

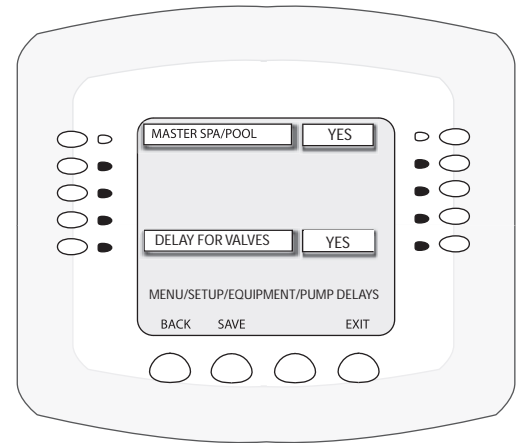

Delay Cancel Feature

For convenience, on a one time basis, the DELAY CANCEL feature will cancel the following safety delays which can be set up in the IntelliTouch system. Please note there is generally not a need to cancel any of these delays except for servicing or testing the system.

- **Heater Cool-Down Delay Cancel:** Shuts Filter Pump off immediately.
- **2-Speed Filter Pump 5 minute START on HIGH SPEED Delay Cancel:** Shifts pump to low speed.
- **Automatic Pool Cleaner START Delay:** Starts Cleaner Pump immediately. Normally there is a delay in which the filter pump first runs for 5 minutes before the cleaner pump starts.
- **Automatic Pool Cleaner-SOLAR Delay:** Allows Cleaner Pump to run even though solar delay has shut it off for 5 minutes.

About the Heater Cool-down Cycle and Delay Cancel

Some heaters require a cool-down cycle before being turned off. This can be accomplished with a SET UP procedure in the IntelliTouch system which runs the filter pump an additional ten minutes to dissipate residual heat built up inside the heater combustion chamber. The DELAY CANCEL feature is mainly for use by service technicians when they want to shut the filter pump off immediately, and know the heater has not been running.

IMPORTANT: Heaters manufactured by Pentair Water Pool and Spa® do not require this cool-down period and do not need the delay to be set up.

To cancel a safety delay:



Go to Delay Cancel Screen

1. Press the button next to **DELAY CANCEL**. Equipment is switched off and ready to be serviced.
2. Press the **Back** button when finished. The system delay is disabled and the system is returned to normal operating mode.

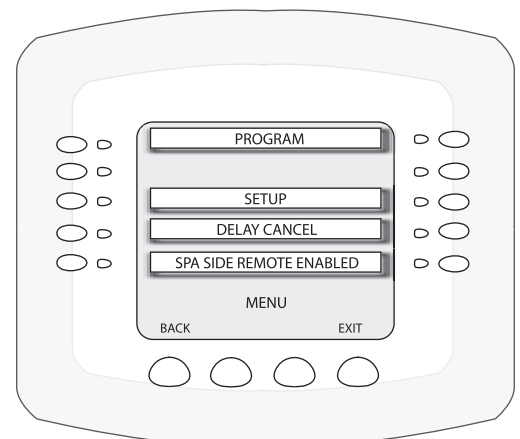

SPA Options

Set Automatic Spa Heating When the Spa is Manually Switched On



Go to the **Spa Options** screen.

1. Press the left or right side button next to **Spa Manual Heat** to change the setting to **Yes** (the default setting for Manual Heat is Yes).

Note: If you do not want the heater to switch on when you press the SPA button, change the factory setting from YES to NO.

Freeze Override 30-240 minutes

2. Press the left or right side button next to **Freeze Override Mins** to change the default freeze protection time of 30 minutes to a maximum of 240 minutes in 30 minutes increments.
3. Press the **Save** button when finished.
3. Press the **Exit** button to return to the main screen.

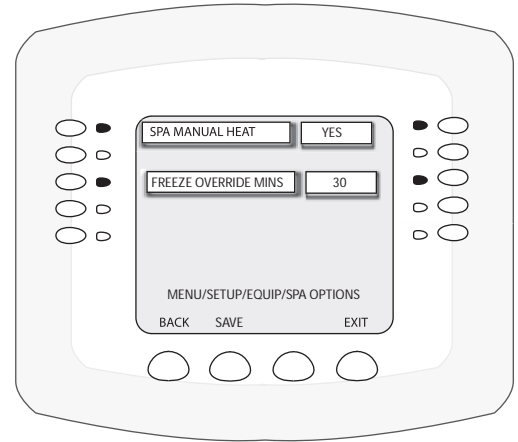

Changing the Display to Show Fahrenheit to Celsius

You can change the temperature settings to display either Fahrenheit or Celsius. Temperature settings can be adjusted from 40° F to 104° F or (4° C to 40° C).



To change the temperature settings go to the **Degrees C/F** screen.

1. Press the left or right side button next to **Degrees Displayed In** to select **C (Celsius)** or **F (Fahrenheit)**.
2. Press the **Save** button.
3. Press the **Exit** button to return to the main screen.

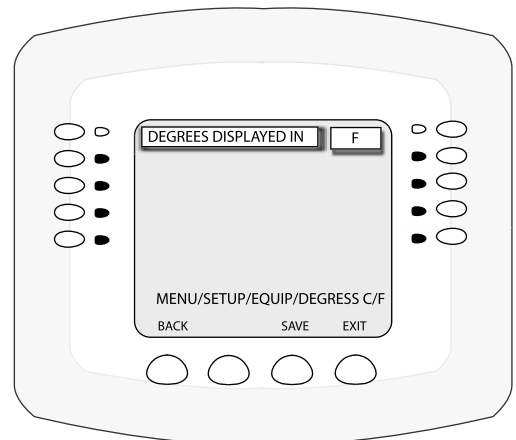

Configuring Valve Actuators (Controlled by AUX or Feature Circuit)

All IntelliTouch systems can drive two auxiliary valve actuators (A and B) for applications such as solar heating and water features. With the addition of the Valve Module (P/N 520285), installed in the Load Center or Power Center, the system will accommodate up to three additional actuators (C, D, and E). An **AUX** circuit or **FEATURE** circuit can control auxiliary valve actuators. By using Feature circuits to control valve actuators, you can conserve your AUX circuits for high voltage relays for controlling pumps and lights. Use Macros to couple valve actuators with AUX circuits for specific applications.

Note: All Personality boards (including i5x and i10x) has two valve outputs A & B. With the addition of the Valve Module (P/N 520285) board that connects to the Personality board, three additional valve operators can be added to the system.

Configuring Valve Actuators

Note: If Expansion Centers are a part of the system, before this screen, you must select which main Load Center or Power Center you wish to configure. The Load Center or Power Center number matches display number (1 through 4).

Go to the Configure Valves screen.



1. Select the button next to the valve actuator you wish to configure. Keep pressing the button until you find the circuit name which you would like to use to control the valve actuator.

Valve A: Resides on the IntelliTouch Personality board. If solar heating is setup AND NOT configured as a heat pump, then this valve is dedicated for controlling the solar heating valve actuator.

Valve B: Resides on the IntelliTouch Personality board next to Valve A.

Valves C, D, E: Reside on the optional Valve Module board that may be plugged into the IntelliTouch Personality board in any Load Center or Power Center.

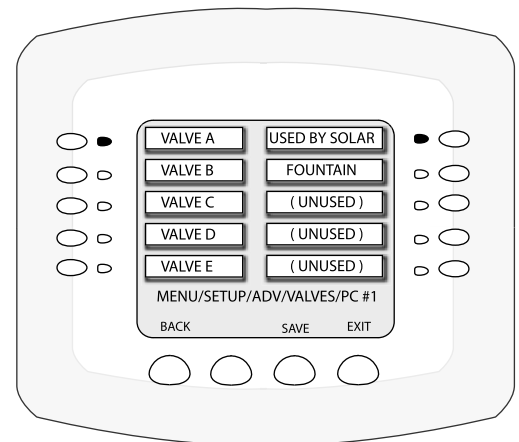

2. Repeat the above steps for each valve actuator.
3. Press **Save** when done.
4. Press **Exit** to return to main screen.

Feature Circuits

Feature Circuits provide a way to control equipment which is not controlled by an AUX circuit. Typically AUX circuits are used for high voltage equipment such as pumps and lights, whereas Feature Circuits are used for valve actuators. However, Feature Circuits can go beyond this definition, and be used in other creative ways. For example, Feature Circuits may be used to create a Macro circuit in which several other circuits can be switched on or off with the same button. This is accomplished by first choosing a name for your Macro and assigning that name to a Feature Circuit. There is a limit of 10 Feature Circuits in the system.

- **Valve Actuators** - Feature Circuits may be assigned for controlling up to five valve actuators per Load Center, which requires the installation of the optional Valve Module P/N 520285 that include three actuators outputs (C, D, and E) per Load Center. For more information about configuring valve actuators, refer to page 70.
- **2-Speed Pump** - A Feature Circuit may be assigned as a way to turn a 2-speed Filter Pump to high speed.
- **Spa Spillway** - A Feature Circuit may be assigned to activate the Spa Spillway effect, where in a pool/spa combination, all of the pool water can be diverted to the spa then spill back into the pool.

Assign a Circuit Name to a Feature Circuit

Note: When assigning circuit names in the Indoor Control Panel, use the written list of circuit names and assigned buttons for the Outdoor Control Panel to make sure that they match.

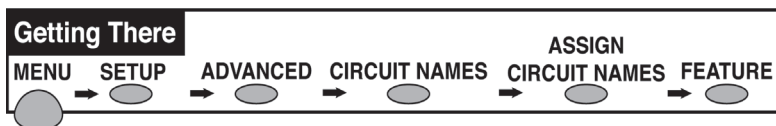

1. Press the button next to the circuit that you wish to assign a name to. A small arrow pointing to the name is displayed.
2. Use the **Up** and **Down** buttons to scroll through the list of preset circuit names (see page 37). If the preset circuit names are not suitable, you can create a custom name (see page 38). Press the Back button twice and select “Create Custom Names” to create a custom circuit name.
3. Press the **Save** button to save the Feature circuit name and return to the Feature screen.
4. To add another Feature circuit, press the button next to FEATURE to add another Feature circuit and repeat step 1, 2 and 3.
5. Press the **Exit** button to return to the main screen.

To view Feature circuits from the main screen: Press the DISPLAY button until the Feature circuit screen is displayed. The **F** icon located in the middle lower part of the screen indicates that Feature circuits screen is selected.

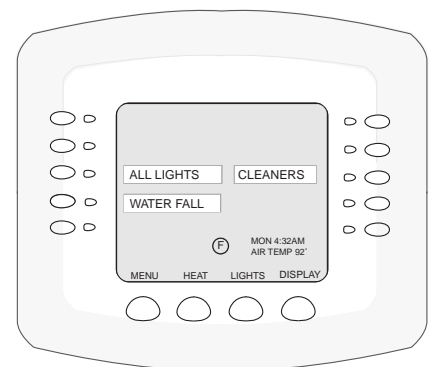
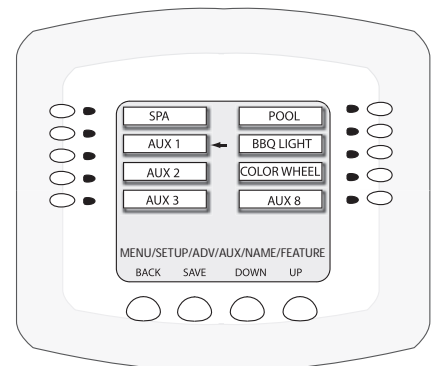

Feature circuits screen

Creating a Macro Circuit

A Macro circuit allows multiple combined circuits that can be switched on or off from a single button. For example, a Macro circuit can be assigned to one button to switch on the spa, spa light, fountain, fountain light, and patio lights. The Macro circuit name (or custom name) can be added to the main list of “IntelliTouch circuit names” (see page 37). A Macro circuit also has the capability to switch a circuit off. For example, a Macro circuit named “SPA PARTY,” if you wanted a spa fountain not to be on when spa is on (because it could put cold water in the spa), it can be set up in the Macro to automatically switch off when “SPA PARTY” is switched on. An “OFF” Macro can also be used to switch any number of lights off with one button.

Note: Macros may not be set as Dimmers although they can turn on light dimming circuits.

To create a macro circuit, go to the **CIRCUIT MACRO** screen.

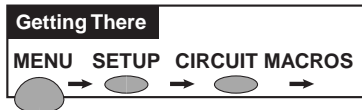

*Note: To create a Macro, first assign a **FEATURE** circuit name (see page 79), assign a function to the Feature circuit (see page 39), then go to the **Circuit Macro** screen and set up the Macro circuit.*

1. The already assigned Feature circuits will be displayed on the Features screen. Ten (10) Feature circuits can be displayed on this screen.
2. Press the button next to the Feature circuit name that will be the MACRO circuit to control other Feature circuits. Press the **DISPLAY** button to toggle between the Feature circuit screen and the Display #1 (1) screen.

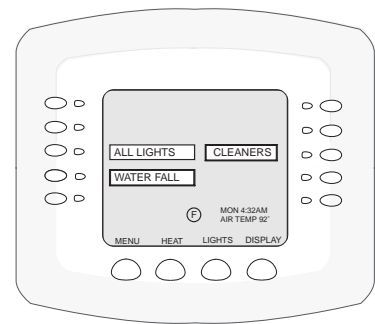

Feature circuits screen

Macro Lights:

- To switch a circuit ON, press the button next to the circuit name one time. The light will be on.
- To switch a circuit OFF, press the button next to the circuit name two times. The light blinks on and off.
- To set a circuit to be unaffected by the macro, press the button next to the circuit name three times. The light is off.

Note: Be careful when you select circuits to switch on. One macro circuit can switch on another macro circuit, resulting in the system incorrectly switching on or off.

3. Press the **Save** button when finished.
4. Press the **Exit** button to return to the main screen.

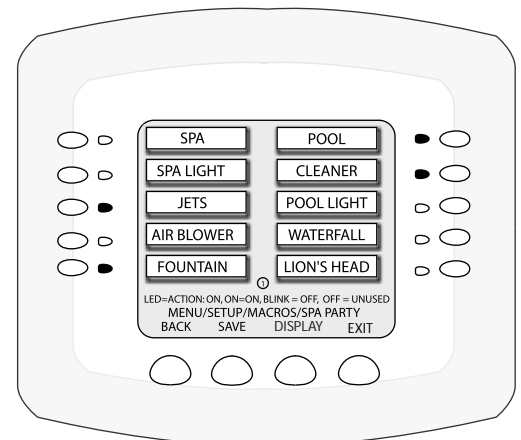

Configuring Remote Control Button Circuits (iS4, iS10, SpaCommand Spa Side Remote, QuickTouch (QT4) and phone remote)

From the spa side remote screen you can configure the iS4, iS10 and SpaCommand® buttons to control different pool/spa functions, including IntelliFlo VF 3050, VS 3050 and VSF+SVRS pump speeds. Up to two iS4 remotes, and four iS10 and SpaCommand remotes can be connected to an IntelliTouch system. To assign a circuits to spa-side remote buttons:



- Press the button next to **CONFIGURE iS4'S** or **CONFIGURE 10 BUTTON SS's** or **CONFIGURE QUICKTOUCH** to select the remote.
 - For iS4:** Press the top button to access the setup screen for **iS4 #1** and **iS4 #2**. See note below if multiple iS4 remotes are installed.
 - For iS10 and SpaCommand:** Press top button to select **10 BUTTON SPA SIDE #1** for the first iS10 or SpaCommand remote. Choose which one of the four remotes you are configuring, **10 BUTTON SPA SIDE #1 #2, #3 or #4**. See note below if multiple iS10 or SpaCommand remotes are installed.
 - For QuickTouch:** Press the button next “CONFIGURE QUICKTOUCH” to access the setup screen.
- On the next screen:** Press the button next to the circuit you wish to assign. A small arrow is displayed pointing to the name of that circuit. Use the **Up** and **Down** buttons at the bottom of the screen to scroll through the iS10 or iS4 circuit names (SPA, POOL, AUX 1-8, HEAT BOOST, HEAT ENABLE, **INCREASE PMP SPD**, **DECREASE PMP SPD**, NONE). **For QuickTouch:** (SPA, POOL, AUX 1-4, POOL). *Note: When assigning buttons to “Increase” and “Decrease” the IntelliFlo VF (GPM), VS (RPM) and VSF+SVRS (RPM/GPM). Each press of the assigned button increases or decreases the pump’s “step” flow rate or speed until the GPM or RPM is reached as specified in the “SPA SIDE INFLO CONTROL” screen (on the 10 Button SS screen). Be sure to set the pump address number (in the IntelliFlo screen) for the pump you wish to control.*
- Continue the process to assign other circuits to the spa-side control buttons. Press the **Save** button to save the settings and return to the previous screen. Press the **Exit** button to return to the main screen. Press **Back** to go back to the remotes screen to configure another remote.

Note: For systems with four iS10/SpaCommand remotes, adding one or two iS4 remotes will affect button function assignments as follows: Assigned button functions 1 - 4 on iS4 #1 are linked with the same functions to buttons 1 - 4 (top row) of iS10 #4. Also, buttons 1 - 4 on iS4 #2 are linked to buttons 6 - 10 (bottom row) of iS10 #4. For example, button 6 on the bottom row of iS10 #4 is linked to button 1 of iS4 #2, button 7 on iS10 #4 is linked to button 2 of iS4 #2, etc.

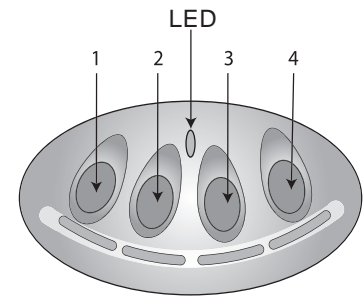

iS4 spa side remote

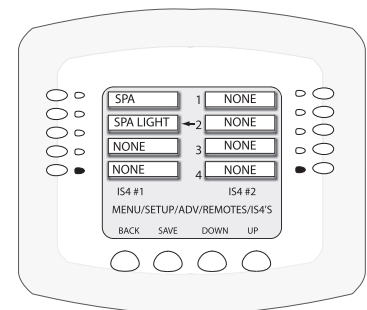

iS4 circuit/button setup

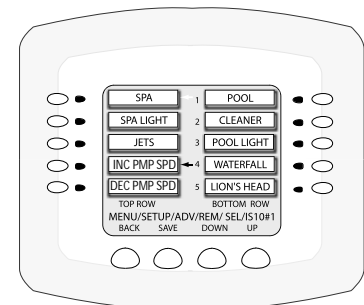

iS10 circuit/button setup

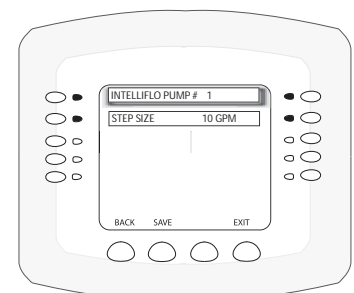

SPA SIDE IFLO CONTROL

Setting up the Remote Control Telephone Feature

The remote control telephone feature allows you to switch on a feature by calling the Indoor Control Panel via the telephone.

You can only use this feature the **TELSPA** needs to be connected to the Personality board COM port, and the phone line.

The following describes how to switch on your spa remotely. You can also scroll through the list of available features and set any one of them. This feature can also be used by a macro circuit (see page 80).

To setup the telephone remote control:



Go to the **Spa RF and Phone Remotes** screen.

1. Press the button next to **CONFIGURE MOD-PHONE** to access the Phone Remote setup screen.
2. Press the top left button next to NONE.
3. Press the **Up** or **Down** buttons to scroll through the available circuit names until you find the function you would like to assign to the telephone remote. Choose the function you will use most often, for example **SPA** allows you to call the system and switch on spa filtration and heating with one command.

***Note:** If you are using the remote to turn on your spa, you must also enable “**MANUAL HEAT.**” This allows the heater to always switch on whenever the spa is switched on via the telephone. For more information, see page 77.*

4. Press the **Save** button to save the setting and return to the remotes screen.
5. Press the **Exit** button.

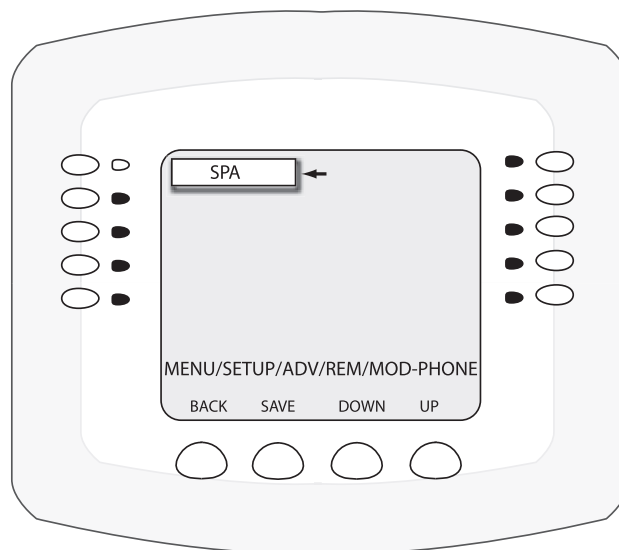

Disable/Enable Spa-Side Remote

This feature is useful if you wish to disable the use of the SpaCommnad and iS4 Spa-Side Remote. You can enable and disable the spa-side remote with the same button. Each time the button is pressed it toggles between DISABLED or ENABLED.

Press the MENU button. The **Spa Side Remote Disable/Enable** screen is displayed.

1. **To Disable:** Press the button next to SPA SIDE REMOTE ENABLED. Screen will immediately display SPA SIDE REMOTE DISABLED. Remote is now off.

To Enable: Press the button next to SPA SIDE REMOTE DISABLED. Screen will immediately display SPA SIDE REMOTE ENABLED. Remote is now on.

2. Press the **Back** button to return to the main screen.

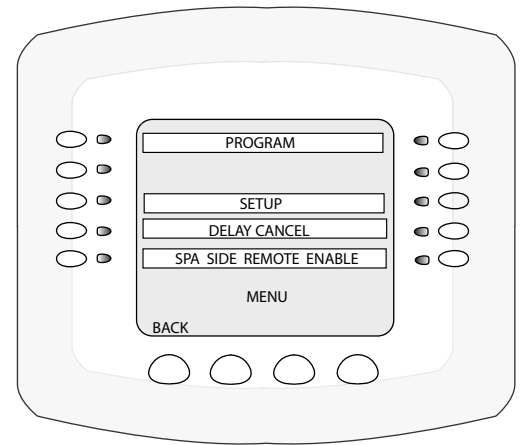

Keypad Lock

If required, the IntelliTouch indoor control panel and MobileTouch wireless control panel can be passcode protected so that system settings and operations cannot be accessed. To access a ‘locked’ control panel, the correct previously assigned four digit passcode must be entered before access is granted.

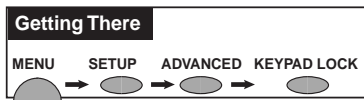

Go to the **KEYPAD LOCK** screen

To assign a four digit passcode and enable the Keypad Lock feature:

1. Press any combination of four digits using the buttons 1-9.
2. Press the ENABLE button to enable the Keypad Lock feature.
3. Press the EXIT button to return to the main screen. Providing the control panel is not active (no buttons pressed), the Keypad Lock feature will be activated in a few minutes.

Clear Button: Press the CLEAR button to erase the previously entered four digit passcode. If the Keypad Lock feature is “Enabled,” pressing Clear will erase the previously entered four digits and reset the feature to “disabled.”

Enable/Disable button:

Enable: Pressing the ENABLE button **after** entering the four digit passcode will enable the Keypad Lock feature.

Disable: Pressing the DISABLE button will disable the Keypad Lock feature while also retaining the previously entered four digit passcode.

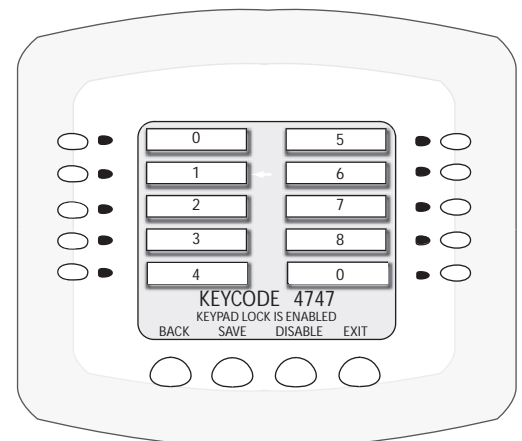
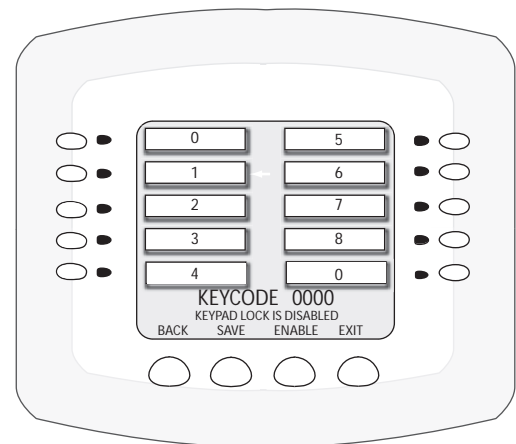

Keypad Lock ENABLED

Calibrating Temperature Sensors

The IntelliTouch system includes two temperature sensors (10 k Ω) for water and ambient air temperature. You can add a third sensor for controlling solar heating systems. Note: The i10+3D system includes three sensors.

Generally, these sensors are accurate and you do not have to calibrate them. However, long plumbing runs and water features cause temperatures at a body of water to be different from the temperature sensor reading. You can manually recalibrate the sensors to adjust for this.

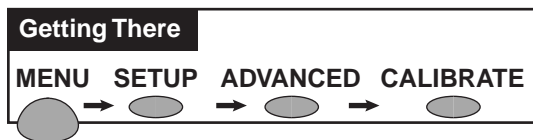

Before you start, you need an accurate all weather thermometer. If you are calibrating the air sensor, wait until the sensor is not in direct sunlight. Be sure that the air sensors are located in the shade for accurate freeze protection.

To calibrate the water and air sensors, go to the **Calibrate** screen.

For i10+3D systems, you will see **Spa Temp**, **Pool Temp**, and **Air Temp**. Calibrate the spa and pool water temperatures the same way as described below for the water sensor. If you have an i5+3, i5S+3, i7+3, or i9+3 system, there is a water sensor and an air sensor. Make sure to locate the air sensor in the shade for accurate readings. Make sure to locate the solar sensor in the sun for accurate readings.

To calibrate the water sensor:

1. Switch on the spa or pool filter pump.
2. Place the thermometer in the spa or pool, depending on the system model number. For shared equipment, you only need to calibrate one body of water.
3. Take an accurate temperature reading.
4. At the Indoor Control Panel, press the buttons next to the **Water Temp** label to adjust the temperature up or down. If you have an i10+3D repeat the above for the pool. The i10+3D has three sensors, one each for the spa and pool water and one for the air temperature. For the Solar option there will be one sensor for the pool solar, and one for the spa solar.
5. Press the **Exit** button when finished.

To calibrate the air sensor:

1. Place the thermometer next to the air sensor. The sensor is normally located near or under the Load Center or Power Center enclosure, not inside the enclosure.
2. Take an accurate temperature reading in the shade.
3. At the Indoor Control Panel, press the buttons next to the **Air Temp** label to adjust the temperature up or down.
4. Press the **Exit** button when finished.

Using the Service Personnel Screen

IntelliTouch system information such as circuit configurations are stored in the outdoor control panel memory. System information relating to user interface settings and ordering of controllers is retained locally at the controller (indoor control panel, MobileTouch, iS10 etc.). All system information is backed up and updated to all indoor control panels, MobileTouch controllers, and the main outdoor control panel periodically. If required, you can upload or down load the current system configuration to and from the outdoor control panel and controllers. This feature is available from the Service Personnel screen.

Checking Firmware Version

The IntelliTouch factory installed operating system software is known as firmware. There is a different firmware program loaded on the controllers (indoor control panel and MobileTouch) and the outdoor control panels. Every time the firmware version is changed it is assigned a new release level number (version #). Changes are made to the firmware to either add functionality or enhance performance. If you need to determine the firmware revision level on the system, perform the following steps.

To check the system firmware version:



Go to the Advanced screen.

1. From the Advanced screen, press **buttons 2 and 4 at the same time**. The Service Personnel screen is displayed.
2. Press the button next to **System Version Info**. The firmware version is displayed for the Indoor Control Panel (UIC) and Outdoor Control Panel (UOC).
4. Press **Back** to exit.
5. Press **Exit** to return to the main screen.

Note: Different controllers may have different revision levels depending on when they were installed. To determine the firmware version of each controller repeat the above steps for each controller.

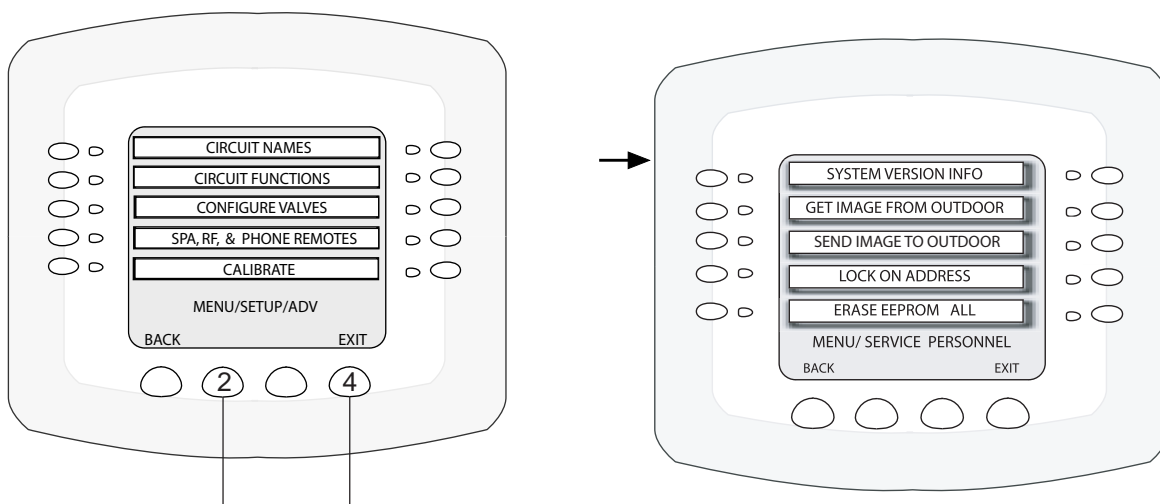

Press both buttons at the same time to access the Service Personnel screen

Manually Updating Between Indoor and Outdoor Control Panels

When the IntelliTouch system configuration settings are changed, or a new component is added, the updated information is automatically communicated to all of the control panels. Configuration settings reside in all the controllers and the outdoor control panel. This feature provides system backup information in the event one of the controllers or control panels is not operational. To update IntelliTouch system configuration information between the indoor and outdoor controllers:

Go to the Advanced screen.

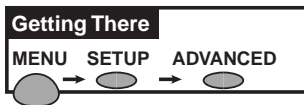

1. From the Advanced screen, press the **2nd. and 4th. buttons at the same time**. The Service Personnel screen is displayed.
2. Press the button next to **Get Image from Outdoor** to download system configuration data residing in the outdoor control panel memory to the Indoor or MobileTouch controller.
3. Press the button next to **Send Image to Outdoor** to upload system configuration data residing in the Indoor or MobileTouch controller to the outdoor control panel. A “stopwatch” icon flashing indicates data is being transferred.
4. When the transfer is finished, press **Back** to exit.
5. Press **Exit** to return to the main screen.

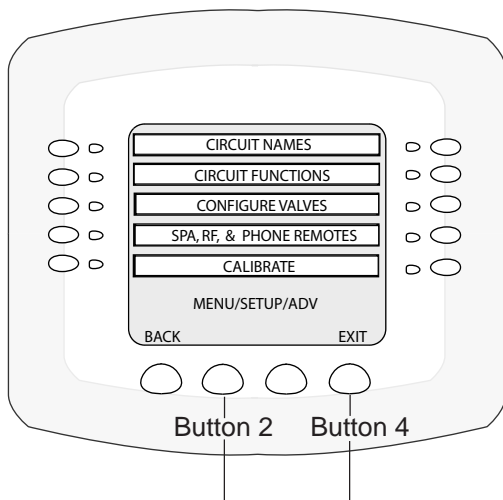

Press both buttons at the same time to access the Service Personnel screen

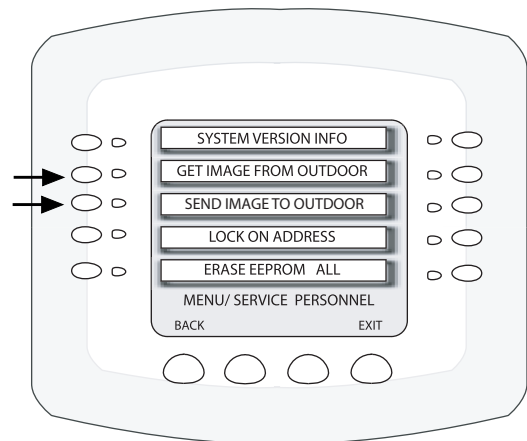

Erasing the System Memory

IntelliTouch system circuit settings, equipment setup configuration information and screen display information is stored in the main Outdoor Control Panel and the Indoor Control Panel and MobileTouch wireless control panel. The current system configuration information automatically downloads from programmed control panels to update non-programmed control panels in case of accidental memory loss. If a circuit board replacement is necessary, system programmed memory can be erased and returned to the factory default settings. Once this is done, the main Outdoor Control Panel (located in the main Load Center or Power Center) will auto-enable all connected Indoor Control Panels. If there are multiple Expansion Center, iS10's, or Indoor Control Panels or a MobileTouch control panels, each one of the controllers will need to be manually enabled (see page 26).

To reset to the system to the factory default settings:

CAUTION: This procedure will erase all system settings. All controllers will need to be manually enabled again. For more information, see page 26.

1. On the main Outdoor Control Panel (located in the main Load Center or Power Center), press the **Reset button**. The three (3) System Control lights will be lit.
2. Press the number **5** button. The System Control lights will flash OFF then back ON.
3. While the System Control LED lights are ON, press the number **1** button.
4. The System Control LED lights will begin flashing on and off.

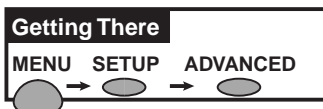
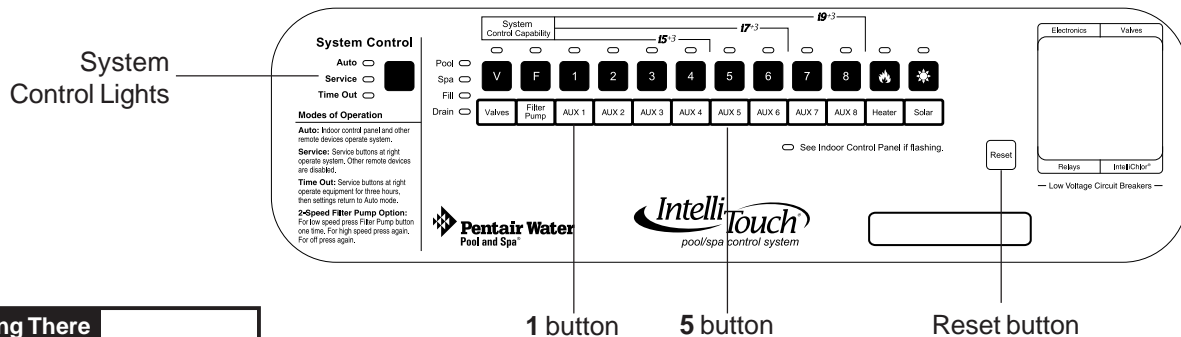

Go to the **Advanced** screen.

5. From the ADVANCED screen, press **Buttons 2 and 4 at the same time**. The Service Personnel screen is displayed.
6. Press the left or right side button next to **Erase EEPROM!!!**
7. At the prompt, press the lower button to select **YES**.
8. Press the **ERASE** button. The screen will blink a few times then return to the main screen. All system configuration data should now be erased and returned to the factory settings.
9. Repeat steps 5-8 for other controllers.
10. At the Outdoor Control Panel press **Reset** and wait for the system to return to "AUTO" mode.

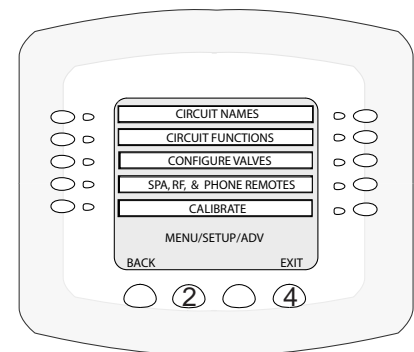

Press both buttons at the same time to access the Service Personnel screen

System Worksheet Overview

System worksheets are provided to help you plan the system at start-up and to keep system records. Make copies of each system worksheet (page 86 - 91) appropriate for the system. Use a unique one for each Load Center or Power Center. Circle the Load Center or Power Center number on the top. Each worksheet is divided into a **Hardwired Connections** and a **Programmable Settings** sections. The Hardwired Connections section represents which relays, actuators, and heater have been plugged into the Personality board. Some connections are mandatory for each system as shown on the work sheet. The Programmable Settings section represents what functionality the circuit will have and from what Indoor Control Panel and/or MobileTouch control panel they are set from.

In the left-side column, write-in temporary circuit names based on the capabilities you want the system to have. For example: Spillway, Solar Heating, Cherub Fountain, etc. Eventually circuit names will be given to each of these capabilities. Although duplicate names can be used, it is best to keep each one unique. Be sure to write the circuit name on the work sheet that will have the hardwired connection.

Write down on the worksheet which Hardwired Connections (relay or valves) will be activated by the circuit. It may be helpful to fill this out at the Load Center or Power Center where the circuits and associated equipment may be quickly verified. Remember the following rules to assist in making marks:

- Assign no more than one relay connection to any auxiliary circuit (shown on Display 1 through 4) EXCEPT for 2-Speed or Feature Circuits.
- Feature Circuits may have multiple relay connections if set up as a Macro.
- Feature Circuits may have multiple valves assigned to them and 2-Speed without being set up as a Macro and with no other relay connection.
- Valves A-E may be assigned to the same auxiliary circuit as a relay connection.
- If one valve is to be turned on by more than one circuit, then it is suggested to assign a Feature Circuit to just that valve. That valve and any combination of relay connections may be activated with Macros.
- If SOLAR relay connection is checked and SOLAR is **NOT** a heat pump, also check Valve A. Valve A may not then be used with any other circuit. Valve A and the SOLAR relay are activated when solar heating is enabled.

Write down Programmable Settings for each circuit, and what special Circuit Functions, if any, each circuit will have. Circuit Functions may be assigned to any number of circuits (see page 39). If Spillway is checked, the Intake and Return valves will turn to divert all the pool intake water to be returned to the spa. If “Floor Cleaner” is checked, then one or more valves must also be checked to run the floor cleaner multi-port valves. If no special function will be assigned check GENERIC.

Write-in any automatically timed programs you want for a circuit. Up to 99 total timed programs may be assigned, but only three are presented on the work sheet. Indicate start times, stop times, countdown time (called “EGG TIMER”), days to be active, and if a color changing light whether or not it should change colors when turned on (SMART START).

Finally, indicate what circuits you want to appear on the Indoor Control Panel main screen and what circuits you want activated by what buttons on a Spa-Side remote. The top buttons of the main screen are dedicated for Spa and Pool modes, however the lower buttons numbered downward may be configured to display any circuit.

Note: *Keep the homeowner worksheets for future reference.*

WORKSHEET FOR SHARED EQUIPMENT SYSTEMS i5+3, i7+3, i9+3 (Sheet 1 of 2)

<p>Create Custom Names At: MENU/SETUP/ADV/ CUSTOMWEDIT</p>		<p>CIRCUIT NAME</p> <p>POOL (may be renamed)</p> <p>SPA (may be renamed)</p>		
<p>Assign Circuit Names At: MENU/SETUP/ADV/ AUX NAMES/DISPLAY 1-4 OR FEATURE</p> <p>NOTE: POOL and SPA may be renamed but they always activate the circuits indicated</p>		<p>FLTR PMP</p> <p>AUX1</p> <p>AUX2</p> <p>AUX3</p> <p>AUX4</p> <p>AUX5</p> <p>AUX6</p> <p>AUX7</p> <p>AUX8</p> <p>AUX 9</p> <p>AUX 10</p> <p>SOLAR</p> <p>2 SPEED</p> <p>SPA</p> <p>ELEC HTR</p>	<p>RELAY CONNECTIONS</p>	
		<p>INTAKE VLV</p> <p>RETURN VLV</p>	<p>VALVES</p>	
		<p>VALVE A</p> <p>VALVE B</p> <p>VALVE C</p> <p>VALVE D</p> <p>VALVE E</p>	<p>OPT. VALVE MOD.</p>	
	<p>Configure At: MENU/SETUP/EQUIP</p> <p>NOTE: If SOLAR is checked also check VALVE A, unless SOLAR is a Heat Pump</p>		<p>GENERIC</p> <p>MASTER CLNR</p> <p>LIGHT</p> <p>DIMMER</p> <p>SAM LIGHT</p> <p>SAL LIGHT</p> <p>PHOTON GEN</p> <p>COLOR WHEEL</p> <p>VALVE</p> <p>SPILLWAY</p> <p>FLOOR CLNR</p>	<p>CIRCUIT FUNCTIONS</p>
	<p>Configure At: MENU/SETUP/ADV/ VALVES/PC#1</p>		<p>IS4 #1</p> <p>IS4 #2</p>	<p>SPA-SIDE REMOTES</p>
	<p>Assign Circuit Functions At: MENU/SETUP/ADV/FUNC/ "Circuit Name"</p> <p>NOTE: Use DISPLAY to toggle through Display 1-4 and Feature Circuits</p> <p>NOTE: If MASTER CLNR is checked FLTR PMP will also turn on; If DIMMER is checked also assign an AUX; If SPILLWAY is checked, RETURN VLV operates; If FLOOR CLNR is checked also assign VALVE A or B</p>		<p>CIRCLE ONE: #1 #2 #3 #4</p> <p>IS10 BUTTON</p>	<p>PROGRAMMABLE SETTINGS</p>
	<p>Configure At: MENU/SETUP/ADV/ REMOTES/IS4'S</p>		<p>TOP ROW</p> <p>BOTTOM ROW</p>	
	<p>Configure At: MENU/SETUP/ADV/ REMOTES/IS10'S</p>			

WORKSHEET FOR SINGLE BODY SYSTEMS i5S+3, i9+3S (Sheet 1 of 2)

HARDWIRED CONNECTIONS		PROGRAMMABLE SETTINGS		
RELAY CONNECTIONS		SPA-SIDE REMOTES		
Create Custom Names At: MENU/SETUP/ADV/ CUSTOM/EDIT	CIRCUIT NAME	LO-TEMP (may be renamed)	HI-TEMP (may be renamed)	
	X	X	FLTR PMP	
				AUX1
				AUX2
				AUX3
				AUX4
				AUX5
				AUX6
				AUX7
				AUX8
				AUX 9
				AUX 10
Assign Circuit Names At: MENU/SETUP/ADV/ AUX NAMES/DISPLAY 1-4 OR FEATURE NOTE: HI-TEMP and LO-TEMP may be renamed but they always activate the circuits indicated			SOLAR	
			2 SPEED	
			ELEC HTR	
			VALVE A	
	Configure At: MENU/SETUP/EQUIP NOTE: If SOLAR is checked, check VALVE A unless SOLAR is a Heat Pump			VALVE B
				VALVE C
				VALVE D
				VALVE E
				OPT. VALVE MOD.
	Configure At: MENU/SETUP/ADV/ VALVES/PC#1			GENERIC
				MASTER CLNR
				LIGHT
			DIMMER	
			SAM LIGHT	
			SAL LIGHT	
			PHOTON GEN	
			COLOR WHEEL	
			VALVE	
			SPILLWAY	
			FLOOR CLNR	
Assign Circuit Functions At: MENU/SETUP/ADV/FUNC/ "Circuit Name" NOTE: Use DISPLAY to toggle through Display 1-4 and Feature Circuits NOTE: If MASTER CLNR is checked FLTR PMP will also turn on; if DIMMER is checked also assign an AUX; If SPILLWAY is checked, RETURN VLV operates; If FLOOR CLNR is checked also assign VALVE A or B				1
			2	
			3	
			4	
	Configure At: MENU/SETUP/ADV/ REMOTES/IS4'S		IS4 #1 BUTTON	1
				2
				3
				4
			IS4 #2 BUTTON	1
				2
				3
				4
Configure At: MENU/SETUP/ADV/ REMOTES/IS10'S			IS10 BUTTON CIRCLE ONE: #1 #2 #3 #4	1
				2
				3
				4
		TOP ROW	5	
			1	
			2	
			3	
			4	
		BOTTOM ROW	5	
			1	
			2	
		3		
		4		
		5		

These connections correspond to Control Panel
 Display 1 for the mother system,
 Display 2 for the 2nd Load Center,
 Display 3 for the 3rd Load Center,
 Display 4 for the 4th Load Center

WORKSHEET FOR SINGLE BODY SYSTEMS i5S+3, i9+3S (Sheet 2 of 2)

Create Custom Names At: MENU/SETUP/ADV/ CUSTOM/EDIT	CIRCUIT NAME															
	LO-TEMP (may be renamed)	HI-TEMP (may be renamed)	START TIME OR EGGTIMER (Y/N)	STOP TIME OR EGGTIMER TIME	DAYS	SMART START (Y/N)	START TIME OR EGGTIMER (Y/N)	STOP TIME OR EGGTIMER TIME	DAYS	SMART START (Y/N)	START TIME OR EGGTIMER (Y/N)	STOP TIME OR EGGTIMER TIME	DAYS	SMART START (Y/N)	#1 HI-TEMP	#1 LO-TEMP
Program At: MENU/PROGRAM			1/ TOTAL						2/ TOTAL						3/ TOTAL	
Configure At: MENU/SETUP/ADV/ CIRCUIT NAMES/ MAIN SCREEN CONFIG																

WORKSHEET FOR DUAL EQUIPMENT SYSTEMS i10+3D (Sheet 1 of 2)

HARDWIRED CONNECTIONS		PROGRAMMABLE SETTINGS		
RELAY CONNECTIONS		SPA-SIDE REMOTES		
<p>Create Custom Names At: MENU/SETUP/ADV/ CUSTOMEDIT</p>	CIRCUIT NAME	POOL (may be renamed)	SPA (may be renamed)	
	X	SPA PUMP		
	X	POOL PUMP		
		AUX1		
		AUX2		
		AUX3		
		AUX4		
		AUX5		
		AUX6		
		AUX7		
		AUX8		
		AUX9		
		AUX10		
		POOL SOLAR		
		POOL 2 SPD		
	POOL ELEC HTR			
	SPA SOLAR			
	SPA 2 SPD			
	SPA ELEC HTR			
<p>Assign Circuit Names At: MENU/SETUP/ADV/ AUX NAMES/DISPLAY 1-4 OR FEATURE NOTE: POOL and SPA may be renamed but they always activate the circuits indicated</p>	VALVE			
		VALVE A		
		VALVE B		
		VALVE C	O.P.T. VALVE MOD.	
		VALVE D		
	VALVE E			
<p>Configure At: MENU/SETUP/EQUIP NOTE: If SOLAR is checked also check VALVE A, unless SOLAR is a Heat Pump</p>		GENERIC		
		MASTER CLNR		
		LIGHT		
		DIMMER		
		SAM LIGHT		
		SAL LIGHT		
		PHOTON GEN		
		COLOR WHEEL		
		VALVE		
		SPILLWAY		
	FLOOR CLNR			
<p>Configure At: MENU/SETUP/ADV/ VALVES/PC#1</p>		IS4 #1 BUTTON		
		1		
		2		
		3		
		4		
		1	IS4 #2 BUTTON	
		2		
		3		
<p>Assign Circuit Functions At: MENU/SETUP/ADV/FUNC/ "Circuit Name" NOTE: Use DISPLAY to toggle through Display 1-4 and Feature Circuits NOTE: If MASTER CLNR is checked FLTR PMP will also turn on; If DIMMER is checked also assign an AUX; If SPILLWAY is checked, RETURN VLV operates; If FLOOR CLNR is checked also assign VALVE A or B</p>		TOP ROW		
		1		
		2		
		3		
		4		
		1	IS10 BUTTON	
		2	CIRCLE ONE: #1 #2 #3 #4	
		3		
		4		
		5		
		1	BOTTOM ROW	
		2		
		3		
		4		
		5		
		1		
	2			
	3			
	4			
	5			
<p>Configure At: MENU/SETUP/ADV/ REMOTES/IS4'S</p>				
<p>Configure At: MENU/SETUP/ADV/ REMOTES/IS10'S</p>				

WORKSHEET FOR DUAL EQUIPMENT SYSTEMS i10+3D (Sheet 2 of 2)

Create Custom Names At: MENU/SETUP/ADV/ CUSTOM/EDIT	CIRCUIT NAME POOL (may be renamed) SPA (may be renamed)	PROGRAMMABLE SETTINGS												MAIN SCREEN CONFIG			
		1/ TOTAL			2/ TOTAL			3/ TOTAL			LEFT		RIGHT				
Program At: MENU/PROGRAM	START TIME OR EGGTIMER (Y/N)	STOP TIME OR EGGTIMER TIME	DAYS	SMART START (Y/N)	START TIME OR EGGTIMER (Y/N)	STOP TIME OR EGGTIMER TIME	DAYS	SMART START (Y/N)	START TIME OR EGGTIMER (Y/N)	STOP TIME OR EGGTIMER TIME	DAYS	SMART START (Y/N)	#1 SPA	#1 POOL			
Configure At: MENU/SETUP/ADV/ CIRCUIT NAMES/ MAIN SCREEN CONFIG																	

The Main Outdoor Control Panel

The main Outdoor Control Panel consists of the Personality board mounted onto a motherboard which is housed inside a Load Center or Power Center. The Outdoor Control Panel includes, control buttons for pumps, filters, and heater, red status lights, and a Reset button. The IntelliTouch Personality board defines the type of equipment installed. The Outdoor Control Panel can be used to override the Indoor Control Panel functions for pool service and for equipment set up. The Outdoor Control Panel is hinged to allow access the rear Personality board.

Note: Pressing System Control buttons at any of the Outdoor Control Panels, will affect the entire system.

CAUTION: Be sure the **High Voltage Cover Panel** is in place over the bottom edge of the outdoor control panel. **DO NOT OPERATE ANY CONTROLS BEFORE READING THE FOLLOWING INFORMATION.**

Shared Equipment Systems i5+3, i7+3, i9+3

System Control

Three LED indicator lights on the far left indicate the current mode of operation.

By pressing the button adjacent to these lights you may toggle through the various modes.

AUTO mode enables all remote controls (Indoor Control Panel, spa-side remotes, radio frequency remotes, etc. Spa-side remotes may still be disabled by the Indoor Control Panel or MobileTouch).

SERVICE mode allows auxiliaries to be operated directly from the Outdoor Control Panel while disabling all other remotes.

Low Voltage Circuit Breakers

To the far right are 3 Amp circuit breakers to protect low voltage circuits. Check these as part of any troubleshooting activity.

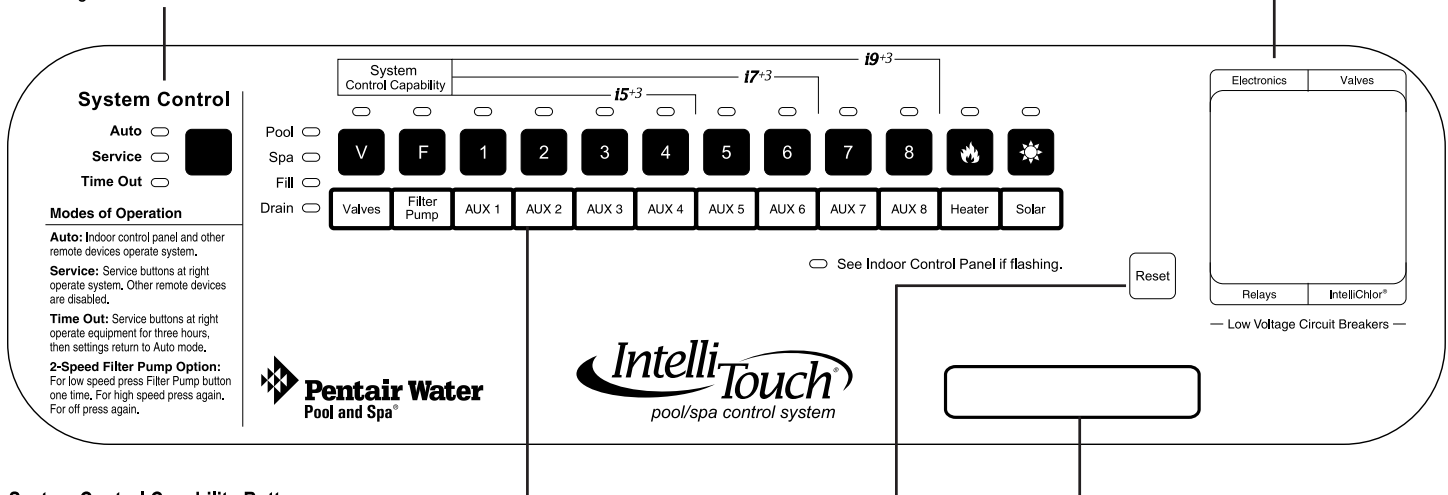

System Control Capability Buttons

In **SERVICE** mode, hitting any of the horizontal buttons will activate the corresponding circuit. Some of the buttons are specially dedicated to certain functions described below.

V: This button will turn valves so that only the pool water is circulated through the system, only the spa water is circulated through the system, the spa will be filled with pool water, or the spa will be emptied of water into the pool. When the system is set to SERVICE mode the actuators will turn to Pool Mode. **NOTE:** a spillway effect may be simulated by setting valves to Fill. Be sure a spillway has been built into the spa.

F: This button will activate the filter pump. If your pump has been wired for two speed operation, the first time this is pressed will put the pump in LOW speed and pressing again will put it in HIGH speed. A third press will turn it off. This button also has further capability during system set-up and configuration.

Heater (Flame): This will automatically turn the heater on. **NOTE:** This does not activate a pump. Heaters should not be activated without running a pump and normally will not run if water flow is not detected. The heater will continue heating the water until the heater's high limit temperature sensor is triggered (approximately 106° F).

Solar (Sun): Two things happen when this is activated. (1) The solar relay is turned on to activate a booster pump if installed. (2) Valves will be turned to divert water through solar heating panels **ONLY IF** the system has been told the solar heating is present through the Indoor Control Panel.

System Identification Label:

System i5, System i7+3,
System i9+3: Main System

Reset

Pressing this button will restart the Outdoor Control Panel. Wait until the System Control indicator light has settled on Auto mode and the Valve indicator light has settled on Pool mode before resuming normal operation. **DO NOT** press any other buttons at this time or you may trigger the Advanced Set-up and Configuration functions.

IntelliTouch Outdoor Control Panels

For IntelliTouch system wiring diagrams, see pages 41-43.

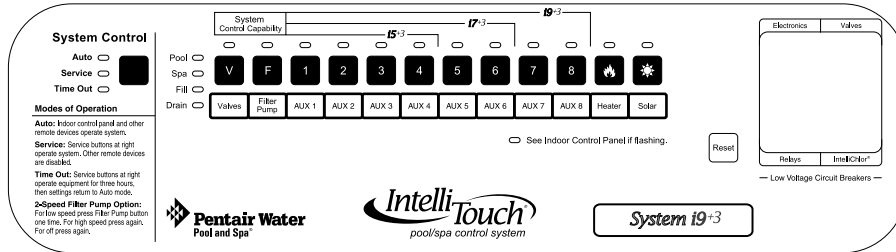

Shared Equipment Systems Model i5+3, i7+3, i9+3

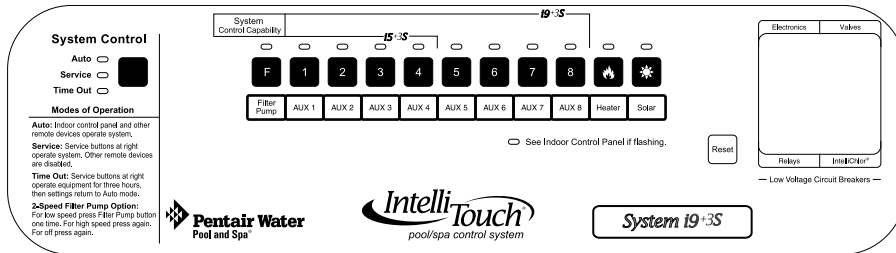

Single Body Systems Model i5+3S, i9+3S

Operates the same as i5+3, i9+3, except no valve controls.

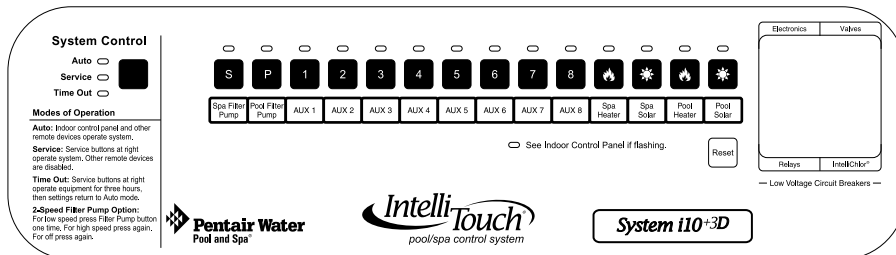

Dual Body Dual Equipment System Model i10+3D

The i10+3D is designed to operate two sets of pool equipment. Each set of a equipment (Pool or Spa) can control one temperature setting. Operation same as i9+3 except S and P buttons operate independent filter pumps and the Heater and Solar buttons operate independent heating systems and no valve controls.

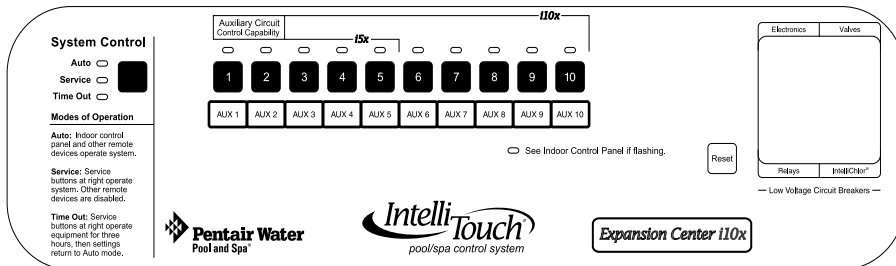

Expansion Centers Model i5x, i10x

Expansion Centers provide additional valve and auxiliary circuits. They are designed to operate with base systems: i9+3, i9+3S, i10+3D. The "Auxiliary circuit control capability" buttons operate the same way as on the main base Outdoor Control Panel.

Erasing Outdoor Control Panel Memory (Factory Default)

The Outdoor Control Panel programmed memory can be erased and returned to the factory default settings. System information such as feature circuit configuration, operation and display is retained at the main Load Center Outdoor Control Panel and all Indoor Control Panels and MobileTouch controllers. If the memory is erased in the main Outdoor Control Panel (located in the Load Center or Power Center), system information retained in the Indoor Control Panel or MobileTouch is automatically downloaded. This feature is important in case of accidental memory loss and to ease board replacement. If there are multiple Expansion Center, iS10 Spa-Side remotes, or Indoor Control Panels, each one of the controllers will need to be manually enabled (see pages 26 and 27 for details). For instructions about erasing system memory from both the Outdoor Control Panel and Indoor Control Panel, refer to “Erasing the System Memory,” page 87.

To reset to the factory default settings:

1. On the Outdoor Control Panel, press the **RESET** button.
2. The three red System Control LEDs are lit for about ten seconds.
3. While the red LEDs are lit, press one of the following buttons
 - For models i5+3, i7+3, i9+3, i5S+3, i9+3S, and i10+3D, press **button 5**.
 - For models i5x, i10x, press **button 7**.
4. The System Control LEDs will switch off then on completing a normal system restart. Wait until the system has returned to “AUTO” and “POOL” modes before resuming operation.

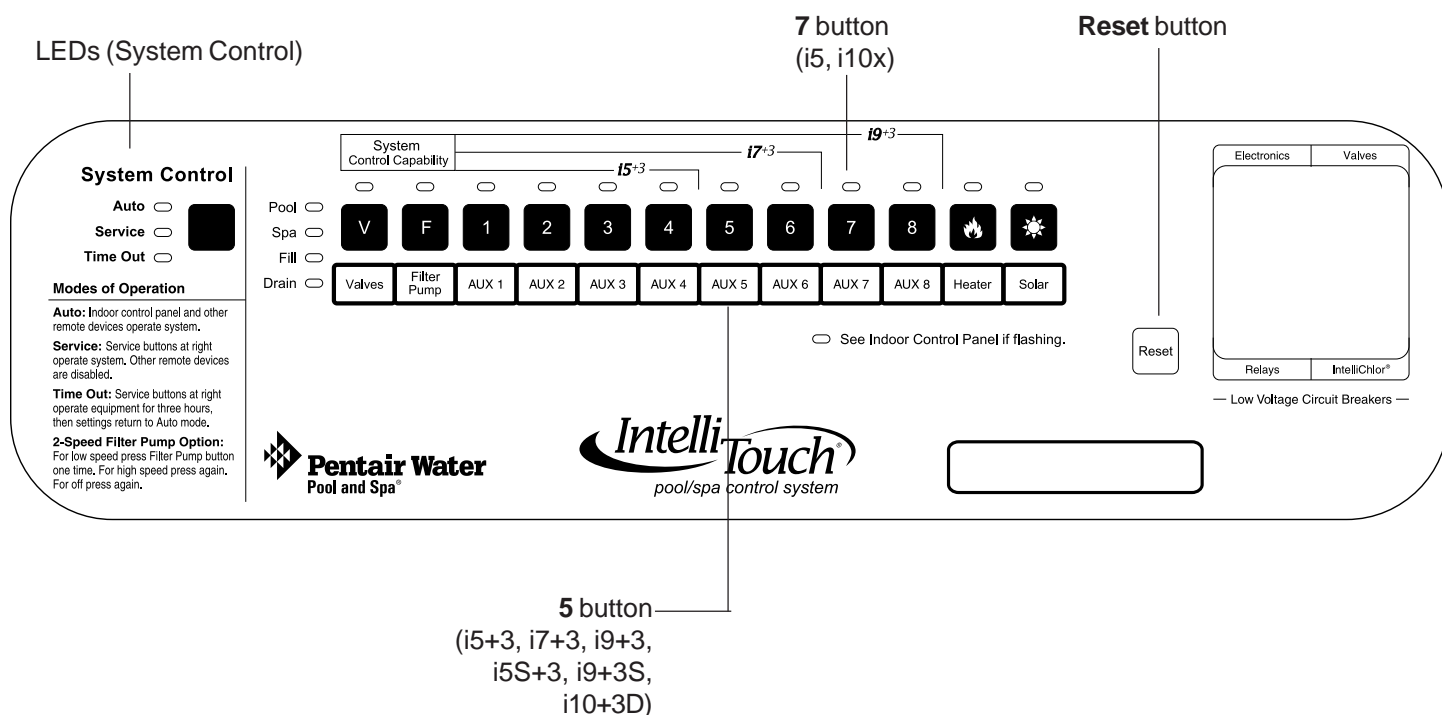

Main Outdoor Control Panel in the Load Center or Power Center

Section 5

Troubleshooting

System Start-Up

The following information describes a basic system start-up procedure. Before switching on the power to the IntelliTouch load center, first affix the auxiliary relay labels to the appropriate buttons on the Outdoor Control Panel. If necessary, write the function on the control panel.

Check Electronics

Check that the following plugs are seated correctly on the Personality board. For connector locations, refer to the System Wiring Diagrams on page 107 and 108.

- Relay connectors - **FLTR PUMP - AUX1 - AUX8**
- Temperature sensors connectors - **WATER, SOLAR, AIR**
- Transformer wire harness - **J2**
- Heater control connector - **ELEC HTR or screw terminals**

System Test

The following describes how to test the Outdoor Control Panel to activate the heater, valves and pumps. This test assumes that all system equipment has been properly installed and connected to the Load Center and Power Center.

Testing Valve Actuators and Pumps:

Use the following steps to test the valve actuators (CVA24T - P/N 263045) for proper rotation. For Outdoor Control Panel System i5+3, i7+3, i9+3 (shared equipment).

To test the valve actuators and pump:

1. Power up the load center. Press the **SYSTEM CONTROL** button on the Outdoor Control Panel until the **SERVICE LED** light is on.
3. Press the **V (Valve)** button to select **POOL**.
4. Press the **F (Filter Pump)** button to activate the filter pump. Water will be removed from the pool and returned to the pool. The bypass valve will allow some water to fall from the spa back to the pool.
5. Set both valve actuators (CVA24T - P/N 263045) for suction and return. Use the toggle switch on the rear of the CVA-24 to withdraw and return water from the pool.

Note: With the filter pump operating, if water is not being removed and returned to the pool, it may be necessary to check the plugs on the Personality board and the toggle switches on the valve actuators.

Troubleshooting

This section provides information to help you resolve any problems that may occur during installing or using the IntelliTouch system. If by following the recommended actions you are still unable to resolve the problems please contact Technical Support, see page vii.

Frequently Asked Questions (FAQ)

What does a '+3' IntelliTouch system mean?

The first number of a "System Personality" indicates the number of high voltage (auxiliary) circuits available including the filter pump. The '+3' indicates the capability of operating additional equipment without using up high voltage circuits. Typically this refers to spillway functionality, valve control (see page 78), and feature circuits (see page 79). A '+3' system also offers moving colored lights, and the ability to create Feature and Macro circuits.

How Do I Setup/Configure/Program the 2-Speed Pump?

Two-speed pumps operate using two relays and one or more circuits with the IntelliTouch system. The first relay turns the pump on or off. Assuming this is the filter pump and depending on the system personality, this circuit is controlled by the Pool, Spa, high temp, or low temp circuits or any other circuit that may be tied to the filter pump (such as circuits with freeze protection, etc.). The second relay turns the pump from low speed to high speed. The default condition is low speed, but up to 10 circuits may be assigned to trigger the pump to high speed. *Note: These 10 circuits do NOT turn the pump on.*

To configure a two-speed pump relay, refer to "Setting Up a 2-Speed Pump," page 75. For relay location and wiring, see pages 107 and 108. The 2-Speed pump relay is plugged into the 2-SPD output on the Personality board. A circuits must be assigned to switch from low to high speed.

Can I turn the Heater On and Change the temperature from the Spa?

The heater may be turned on from the spa using one of two hard wired Spa-Side remote (iS4 or iS10) or by wireless remote controls (MobileTouch or QuickTouch). Only the iS10 or wireless controllers can change the temperature from the spa location.

How do I get Solar to switch on?

The system must first be told that solar heat is installed. Go to the Solar equipment screen (**Menu > Setup > Equipment > Solar**) and press the **YES** button to tell the system solar is present. Note: Do not set solar as a heat pump. Then the heating method must be selected for each body of water. Many options are available through the Heat screen (see page 71).

What are Color Swim and Color Set?

Color Swim: Allows any combination of up to twelve *SAm*, *SAL*, IntelliBrite, and/or *FIBERworks* lighting circuits to be preset to transition through colors in sequence, giving the appearance of the colors swimming across the water. The delay in sequencing each light can be adjusted to customize the display for your pool. For more information see “Setting Up Lighting Options,” page 42.

Color Set: Allows any combination of up to twelve *SAm*, *SAL*, IntelliBrite, and/or *FIBERworks* lighting circuits to be preset to specific colors, such as red, white, and blue for the Fourth of July or red and green for Christmas.

How do I get *SAm/SAL/PG2000* to Synchronize?

There are many ways to configure color changing lights to synchronize on the same colors. The first step is to assign all color changing light circuits a circuit function such as *SAm*, *SAL*, Photon Generator, or Color Wheel. Refer to “Assign Circuit Functions and Freeze Protection,” page 39.

To manually synchronize the lights, use the **Sync** button on the Lights screen. Refer to page 13 for details about how to setup the circuits to appear on the **Lights** Screen.

Light circuits may be controlled to switch on at a particular time and synchronize automatically. This may be done by using the **Smart Start** functionality in the Program Screen. See page 15 for programming details.

Can I copy a standard configuration to all the systems I install?

Yes you can but only if you maintain a standard system configuration on a system in your headquarters. An Indoor Control Panel with a properly wired four conductor patch cable may be used to accomplish this.

 **CAUTION** - Do NOT use the Service Panel. This accessory auto erases every time power is removed. It is for on-site work only.

1. Plug the Indoor Control Panel into a COM port on the Personality board of dedicated system at headquarters.
2. One of several things may happen at this point:
 - The Indoor Control Panel may automatically download the system configuration if its own memory was erased.
 - You may be prompted to update system personality, see page 86.
 - You may be prompted to select Indoor or Outdoor memory. Always Select Outdoor or you will write over your dedicated set up.
 - You may have to force a download to the system.
3. This same controller may then be taken to the job-site to configure the system. Switch off the system power. Open Load Center or Power Center front door, remove the two retaining screws and fold down the Outdoor Control Panel.
4. Plug in the Indoor Control Panel to one of the COM ports from headquarters.

 **CAUTION** - Be sure to check that the wiring is matching both ends before turning system power back on. Crossed wiring may permanently damage the system.

5. The procedure is identical to Step 2 above. Plug into the COM port on the Personality board in the Load Center or Power Center. Again, several different things may happen. Check all the relevant sections to avoid any problems.

Fixing mismatched system personalities

Sometimes the Indoor Control Panel or MobileTouch will have communication problems with the Outdoor Control Panel or with each other. The possible cause may be as follows:

1. A controller is added or replaced. Accessory and replacement controllers leave the factory identified as an i9+3 system.
2. A controller's memory is erased while unplugged from the system.
3. The IntelliTouch system personality (i9+3, i10+3D etc.) was changed.

If this problem occurs a mismatched system personality message screen may be displayed. Press the NEXT button to update the controller to match the system personality. If you do not want to update the controller (most likely because you are service person using the controller for another purpose) then press IGNORE.

Indoor Control Panel and Outdoor Control Panel Connection Problem

System information relating to circuit configuration, operation and display is retained at the main Load Center Outdoor Control Panel and all Indoor Control Panels and MobileTouch. System information is automatically downloads from programmed components to non-programmed components in case of accidental memory loss and to ease board replacement.

If for some reason the controller and outdoor control panel both have user settings that conflict with each other then this must be reconciled. Such occasions include but are not limited to:

1. The MobileTouch wireless controller made changes while the system power was down.
2. A service company made a special upgrade and installed it on an existing system.

If the Service Personnel screen appears, choose Indoor to use the controller settings and Outdoor to use the Outdoor Control Panel settings. Refer to page 85 for more information.

MobileTouch Temperature Readout Not Accurate (20 to 30 Degrees off)

Problem: If the MobileTouch wireless controller LCD temperature readout displays an inaccurate reading, it may be due to wireless signal interference. In this case, the air temperature readout can be correct.

Description: Temperature sensor cables are picking up signal interference.

Solution: To prevent signal transmission interference, ensure that the temperature sensor cables that connect the sensor to the Load Center are not routed near a Florescent lighting fixture (within six (6) inches).

System Problem Diagnosis

Use the following information to resolve system problems.

Problem: The system works in Service Mode, but Indoor Control Panel fails to operate.

Symptom	Possible Cause	Solution
Indoor Control Panel has no power - (screen, blank , no LEDs, buttons not working.	Bad wiring run from Outdoor Control Panel/Personality board in the Load Center or Power Center	Check wiring, and screw terminal connections. Ensure no wires are broken or shorted. Create/Use a short test cable and connect the indoor panel directly to the power center. Correct the wiring order between all units. In some cases this may cause permanent damage. If this occurs contact Technical Support for replacement PCBs. This is most effectively determined by using a spare Indoor controller or Service man's panel. Contact Technical Support for replacement PCB
	Wired incorrectly (wires not in correct order)	Correct the wiring order between all units. In some cases this may cause permanent damage. If this occurs contact tech support for replacement PCBs.
	Defective Indoor Control Panel	This is most effectively determined by using a spare Indoor controller or service man's panel. Contact tech support for replacement PCB
Indoor panel Lights up, but fails to operate correctly. The unit will not turn equipment on/off, or may turn some items on, but not off and may not LEDs near buttons on indoor panel.	Defective Cable/wiring	Verify cable and insure no connections are broken. In some cases a wire is broken under the insulation. The two center wires of the four conductor cable are suspect (Green and Yellow)
	This is most effectively determined by using a spare Indoor controller or service man's panel. Contact tech support for replacement PCB	This is most effectively determined by using a spare Indoor controller or service man's panel. Contact tech support for replacement PCB. In systems with multiple control panels/IS10 determine fault - call Technical Support
Indoor Control Panel not responding.	Incorrect address.	Indoor control Panel has a different address than the Outdoor control Panel. Press RESET then AUX 1 button. Go to the Indoor Control Panel and lock on ADDRESS.

Problem: Indoor and Outdoor Control Panels work, but iS4 fails to operate.

Symptom	Possible Cause	Solution
iS4 Spa Side fails to operate equipment .	Spa Side Control is Disabled by main panel.	Using the indoor panel or a service man's panel. Press 'MENU' and insure the selection reads "SPA SIDE REMOTE ENABLED". If it reads "SPA SIDE REMOTE DISABLED" press the button beside the option to toggle the selection.
	Incorrect configuration or circuit to switch assignment or defective wiring.	Verify iS4 setup. Press 'MENU/SETUP/ADVANCED/SPA, RF, & PHONE REMOTES' Select 'CONFIGURE iS4's' Insure the iS4 in question has the expected circuit assignments, and is not assigned to unused circuits.
	Defective iS4	Replace defective iS4
iS4 fails to operate only some of the switches, but others work fine.	Defective wiring on one or more iS4 leads	Verify wiring as described above
	Incorrect configuration or circuit to switch assignment.	Verify configuration as described above
	Defective iS4	Test and verify iS4 with a Volt-Ohm meter. Replace defective iS4. Contact Technical Support. if unit is still bad.

Problem: Indoor and Outdoor Control Panels work, but iS10 fails to operate.

Symptom	Possible Cause	Solution
iS10 Spa Side fails to operate equipment .	Spa Side Control is Disabled from the main control panel.	Using the indoor panel or a serviceman's panel. Press 'MENU' and ensure the selection reads "SPA SIDE REMOTE ENABLED". If it reads "SPA SIDE REMOTE DISABLED" press the button beside the option to toggle the selection.
	Defective Wiring	Verify iS10 setup. Press 'MENU/SETUP/ADVANCED/SPA, RF, & PHONE REMOTES>Select 'CONFIGURE iS10's' . Ensure the iS10 in question has the expected circuit assignments, and is not assigned to unused circuits.
	Incorrect configuration or circuit to switch assignment.	Verify iS10 setup. Press 'MENU/SETUP/ADVANCED/SPA, RF, & PHONE REMOTES>Select 'CONFIGURE iS10's' Ensure the iS10 in question has the expected circuit assignments, and is not assigned to unused circuits.
	iS10 is not correctly enabled	See page 80 to manually enable the iS10.
	Defective iS10	Replace defective iS10. Contact Technical Support.
iS10 fails to operate only some of the switches, but others work fine.	Defective wiring on one or more iS10 leads	Verify wiring as described above. This is rare, and normally the only wire lead that can cause this would be the 'Green' wire. Verify Connection.
	Incorrect configuration or circuit to switch assignment.	Verify configuration as described above
	Defective iS10	Test and verify iS10 with a Volt-Ohm meter. Replace defective iS10. Contact Technical Support. if unit is still bad.

Problem: The Mobile Control Panel will not work, or will not work dependably.

Symptom	Possible Cause	Solution
The MobileTouch fails to operate. It does not turn on or light up.	Battery is not charged or unit is not plugged in.	Attached the AC recharger into the MobileTouch and plug into a wall outlet.
	Defective MobileTouch.	Replace unit. Contact Technical Support.
The MobileTouch fails to operate.	The unit has not been enabled correctly.	See page 28 to manually enable the MobileTouch.
	Defective Wiring - The Transceiver attached to the Load Center or Power Center is not correctly wired.	Verify Wiring, and wiring order. Check for broken wires and loose connections.
	Defective Transceiver at the Load Center or Power Center.	Verify that the two LEDs on the Transceiver are active as expected. The LED marked POWER should always be lit. The LED marked LINK ACTIVITY should flash approx. every two seconds or whenever there is communication (such as when you press a button on the MobileTouch).
	Defective MobileTouch.	Replace unit. Contact Technical Support.
The MobileTouch fails to operate dependably.	Defective Wiring - The Transceiver attached to the Load Center or Power Center is not correctly wired.	This is rare, and normal, only the green wire would cause this problem. Verify Connection.
The MobileTouch has very poor operating range	Less than optimum location of the Transceiver connected to the Load Center or Power Center.	Relocate the transceiver to allow a less obstructed path between the MobileTouch and the Transceiver.
The MobileTouch range is no more than 30 feet even with clear line of sight operation to the Transceiver.	Defective unit or Transceiver. Likely defective or broken antenna or internal antenna connection.	Contact Technical Support.

Problem: The Quick Touch remote will not work, or will not work dependably.

Symptom	Possible Cause	Solution
POWER LED does not light on the Receiver PCB	IntelliTouch Load Center or Power Center does not have power.	Ensure power is being supplied and that the power center operates correctly without the receiver installed.
	Defective cable or connection to the Load Center or Power Center.	Verify the function of the board using known good cable set. Check all wiring.
	Defective Receiver board.	Contact Technical Support.
COMM LINK LED does not light or blink. In normal operation LED will blink at least every 2 seconds	Defective cable or connection to the Load Center or Power Center.	Verify the function of the board using known good cable set.
	Defective receiver board.	Replace receiver board.
Address switches are incorrectly configured	Verify that the address switches on the transmitter and handheld receiver board are correct and match.	Transmitter battery has failed.
	Replace Transmitter battery	Defective Transmitter or Receiver
	Contact Technical Support.	
Unit functions, but some circuits do not work, or operate the incorrect circuit	QuickTouch configuration is incorrect.	Verify QT setup. Press 'MENU/SETUP/ADVANCED/SPA, RF, & PHONE REMOTES' Select 'CONFIGURE QUICKTOUCH' Ensure the QuickTouch has the expected circuit assignments, and is not assigned to unused circuits
Unit fails to operate, or fails operate dependably at range	Undue electrical noise	Relocate the receiver away from equipment such as blower motors.
	Too many obstructions between the transmitter and receiver.	Relocate receiver.
	Receiver unit is too near the ground.	Relocate the receiver to maximize the distance between the receiver antenna and the ground.

Problem: The Quick Touch remote will not work, or will not work dependably (Continued).

Symptom	Possible Cause	Solution
Unit seems to turn on or off circuits without the user / transmitter	A near by home is operating a similar wireless unit	Select a an alternate address code for the transmitter and receiver. I.e. change the switches on both boards to an alternate, but matching setting.
Unit dependably turns equipment ON, but once equipment is running it does not dependably turn equipment OFF, or range is greatly reduced when equipment is running	Undue electrical noise is being produced by one or more pieces of equipment in close proximity to the receiver.	Relocate the Receiver away from equipment such as blower motorsRelocate the Receiver in a location that provides fewer obstructions to the area the user commonly operates the transmitter.
Unit operates, but has greatly reduced range compared to prior function	Transmitter Battery is failing	Replace Transmitter battery

IntelliFlo Alerts and Warnings

The IntelliFlo displays all alarms and warnings on the control panel display. When an alarm or warning condition exists, the corresponding LED will be lit on the display. All control panel buttons are disabled until the alarm or warning is acknowledged with the **Enter** button. Press the **Reset** button to clear the alarm once the fault condition has been resolved. Note: The IntelliFlo pump will not start if the impeller is rotating. The alerts and warnings are:

- **Power out failure:** The incoming supply voltage is less than 170 VAC. The drive faults to protect itself from over current. The drive contains capacitors that keep it powered up long enough to save the current run parameters. If power is restored during this process, approximately 20 seconds, the drive will not restart until completed.
- **Priming error:** If the pump is not defined as primed within the "Max Priming Time" it will stop and generate a "Priming Alarm" for 10 minutes, then attempt to prime again. The "Max Priming Time" is set by the user on the priming menu as discussed on page 14. If the IntelliFlo cannot prime within five attempts it will generate a permanent alarm that must be manually reset.
- **Overheat alert:** If the drive temperature gets above 130 degrees, the IntelliFlo will slowly reduce speed until the over temperature condition clears.
- **Anti-freezing:** When active, the motor will run at 1000 rpm for 60 minutes. Only active in Filter and Manual modes. Note: The IntelliFlo's internal anti-freeze protection is disabled when connected to an IntelliTouch system. Freeze protection is provided by selecting YES at the ON WITH FREEZE portion of the IntelliTouch's appropriate circuit function menu. To re-enable the IntelliFlo's internal anti-freeze protection, the power to the drive must be cycled off then back on.
- **Blocked system:** Detects a blocked suction line. This alarm resets automatically after 30 seconds and the pump restarts.
- **System service soon:** Alerts the operator that the pump discharge pressure has reached the Clean Filter Pressure as setup in the Filter Menu. The filter status will be displayed as 100%. The yellow warning LED will be on until a backwash cycle is operated. The IntelliFlo will automatically reduce speed as necessary to not exceed the Clean Filter Pressure.
- **Over current:** Indicated that the drive is overloaded or the motor has an electrical problem. The drive will restart 20 seconds after the over current condition clears.
- **Over voltage:** Indicates excessive supply voltage or an external water source is causing the pump and motor to rotate thereby generating an excessive voltage on the drives internal DC bus. The drive will restart 20 seconds after the over voltage condition clears.

Note: For IntelliFlo troubleshooting information, see the following manuals: IntelliFlo VF 3050 (P/N 350075), IntelliFlo VS 3050 (P/N 357269) and IntelliFlo VSF+SVRS (P/N 351420).

Suction Blockage

When something blocks the suction or the pump fully it will shut off immediately (within 1 second). It will also shut off after a few seconds of dead heading with the same alert. The unit will come back on in 30 seconds and ramp up slowly. This function should be tested with all new installations by directing the flow to one suction and covering it with a piece of material other than someone's hand. This alert is deactivated in Manual mode.

IntelliFlo VS 3050 and IntelliFlo VSF+SVRS Warning and Alarm Conditions

The IntelliFlo VS 3050, IntelliFlo VS+SVRS and IntelliFlo VSF+SVRS alarms and warnings are indicated by flashing LEDs on the control panel. For example, if a “Drive Temperature” warning occurs, the LED will blink two times, then Off, then blink two times. This sequence is repeated until the condition is cleared.

- **Warning condition:** If a warning condition occurs the pump will continue to run but at a reduced speed. The Green LED executes a sequence of blinks to indicate which alarm or warning has occurred.
- **Alarm condition:** If an alarm condition occurs the pump will drive stop running. The red LED flashes continuously to indicate the presence of an alarm. The alarm LEDs will reset when the condition clears.

Note: For IntelliFlo troubleshooting information, see the following manuals: IntelliFlo VS 3050 (P/N 357269) and IntelliFlo VSF+SVRS (P/N 351420)

Alarm and warning LED sequence

Number of time the LED will blink	Alarm	Description	Action
2	Drive Temperature Warning	Excessive drive temperature	<ol style="list-style-type: none"> 1. Ensure the motor fan has adequate area for ventilation. 2. Stop motor and allow to cool. 3. Run motor at a higher speed to improve cooling air flow.
5	Unknown alarm	Electron failure	<ol style="list-style-type: none"> 1. Cycle power to reset pump. 2. Replace drive.
6	Drive Temperature Alarm	Excessive drive temperature	<ol style="list-style-type: none"> 1. Ensure the motor fan has adequate area for ventilation. 2. Run motor at a higher speed to improve cooling air flow.
7	Power Out Alarm	Supply voltage low	Ensure proper supply voltage.
8	Over current Alarm	Excessive drive current	<ol style="list-style-type: none"> 1. Examine fluid/mechanical system for source of overload. 2. De-energize motor and determine if motor spins freely. 3. Replace drive.
9	Over voltage Alarm	Excessive voltage on drive buss	<ol style="list-style-type: none"> 1. Rapid switching between speeds can cause excessive voltages on the drive's DC buss. 2. Ensure proper supply voltage.

IntelliTouch System Wiring Diagram (i5+3, i7+3, i9+3)

WARNING PREVENT ELECTROCUTION
 INSTALL AT LEAST 5 FEET (1.2m) FROM INSIDE WALL OF POOL OR SPA.
DISCONNECT ALL SUPPLY CONNECTIONS BEFORE SERVICING. THIS APPLIANCE MAY HAVE UP TO 11 SUPPLY CONNECTIONS.

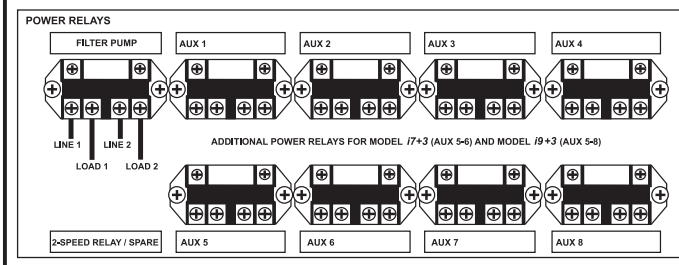
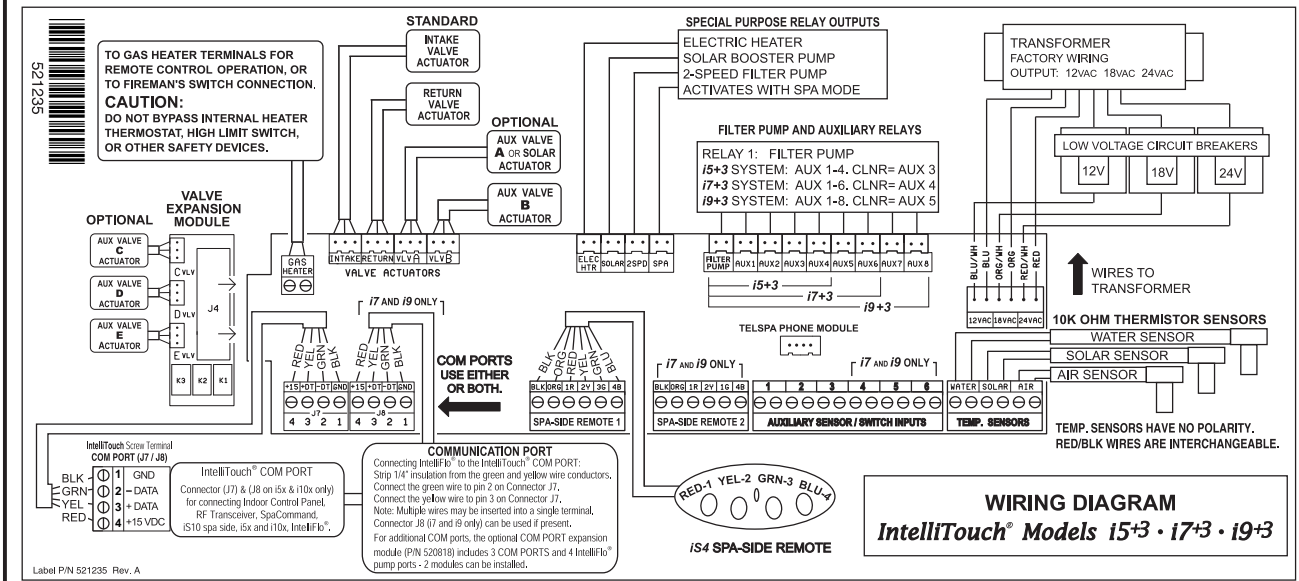

PREVENT WATER DAMAGE
KEEP DOOR CLOSED

A disconnecting means must be located within sight from the equipment and at least 5 feet (1.52 m) from the inside walls of the pool, spa or hot tub.

IntelliChlor®
SALT CHLORINE GENERATOR OPTION FOR OUTDOOR USE ONLY

TRANSFORMER INPUT:
 120VAC @ 2.5A, 50/60 Hz - 240VAC @ 1.3A, 50/60 Hz
 WIRING CONFIGURATION FACTORY SET FOR 240V.

WARNING! DISCONNECT LOAD CENTER BEFORE SERVICING SCG TRANSFORMER.
 Connect this chlorinator transformer to the FILTER PUMP RELAY ONLY. The chlorinator should only be powered when the Filter Pump is ON.

SCG TRANSFORMER WIRING

240V Line Voltage Transformer Leads

- YELLOW
- VIOLET/BLUE
- BLACK
- WHITE

120V Line Voltage Transformer Leads

- YELLOW
- BLACK
- VIOLET/BLUE
- WHITE

CAUTION: RISK OF ELECTRIC SHOCK, READ INSTALLATION MANUAL.
IMPORTANT: This Control Panel must be installed in compliance with the National Electrical Code (NFPA 70) including article 680, as well as all local Authority Having Jurisdiction requirements. Mount enclosure with conduit holes down. This control is not provided with integral GFCI protection for the lighting circuit. When this control is used to power or switch an underwater luminaire, suitable GFCI protection shall be provided in the field. Follow manufacturers' instructions for installing and testing of Ground Fault Circuit Breakers (GFCB) and Interrupters (GFCI); (Canada Class A GFCI). An APPROVED GFCI duplex receptacle may be installed in the rectangular knockout provided on the right side of the enclosure. If the panel is installed outdoors, an APPROVED TYPE 3R (RAINPROOF) Cover MUST be installed over the wiring device in the rectangular opening. Make sure connections inside the low voltage compartment are well insulated, connectors properly seated and wiring lugs tightened. After wiring is completed, install front panel over wiring compartment opening.

WARNING
 DO NOT USE AN EASYTOUCH® OR INTELLITOUCH® SYSTEM TO CONTROL AN AUTOMATIC POOL COVER. SWIMMERS CAN BECOME ENTRAPPED UNDER THE COVER, WHICH COULD RESULT IN INJURY AND/OR DEATH.

TYPE 3R "Rainproof" (IPX3). Enclosure suitable for INDOOR or OUTDOOR USE. Control Panel suitable for SWIMMING POOL/SPA applications.
 Electrical Rating: 120/240VAC 150 AMP Single Phase (3 Wire).
 The input line to this control panel should be protected by a 240VAC circuit breaker rated at NO MORE than 150 Amperes maximum.
 Control Transformer Input: 120VAC, 2A; 240VAC, 1A, 50/60Hz.
 SCG Transformer Input (if equipped): 120VAC, 2.5A; 240 VAC, 1.3A, 50/60 Hz.
 Short Circuit Current Rating: 5000 RMS SYMMETRICAL AMPERES.
 Use COPPER CONDUCTORS ONLY.
 Use 14 AWG to 6 AWG, 60/75°C Copper conductors for all field wiring.



CONTROL TRANSFORMER WIRING

RELAY CONTACT OUTPUT
 General: 25A, 277VAC

PUMP	LIGHT
1.5 HP 120 VAC	1.5 KW 120 VAC TUNGSTEN
3 HP 277 VAC	4.8 KW 240 VAC TUNGSTEN
20 FLA/120 LRA, 120 VAC	20A, 277 VAC BALLAST
17 FLA/102 LRA, 277 VAC	

UL LISTED
 POOL/SPA CONTROLLER
 5K42

Sanford NC • Moorpark CA Customer Service 800-831-7133

IntelliTouch System Wiring Diagram

IntelliTouch System Wiring Diagram (i10+3D, i5+3S, i9+3S and i10+3D)

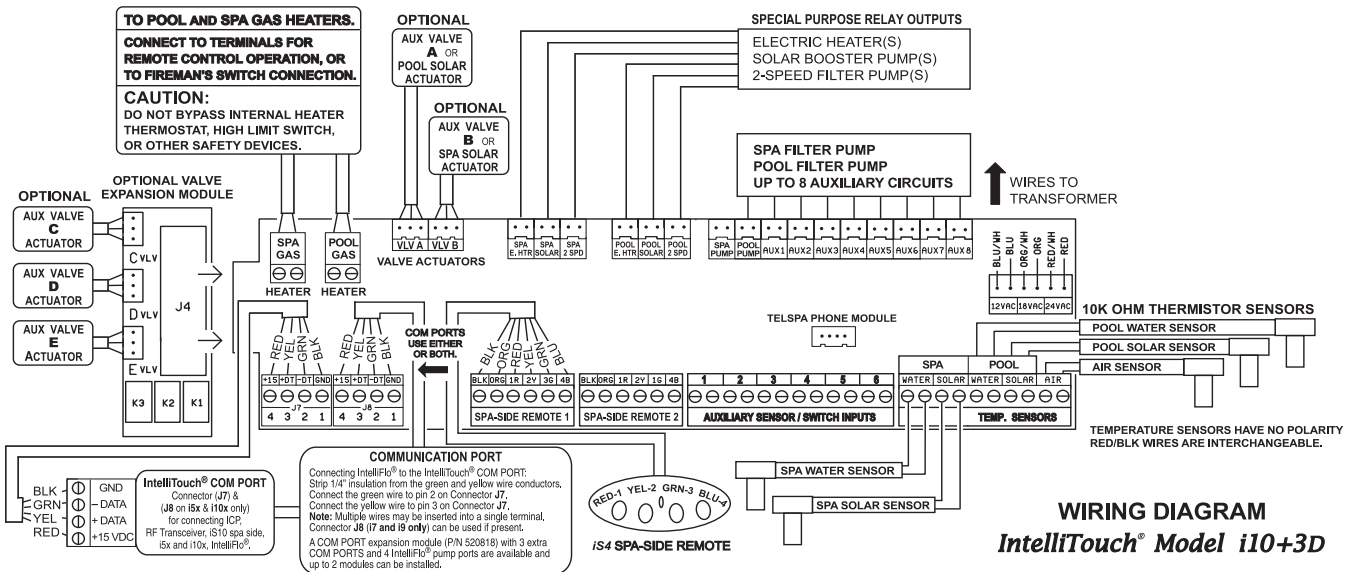
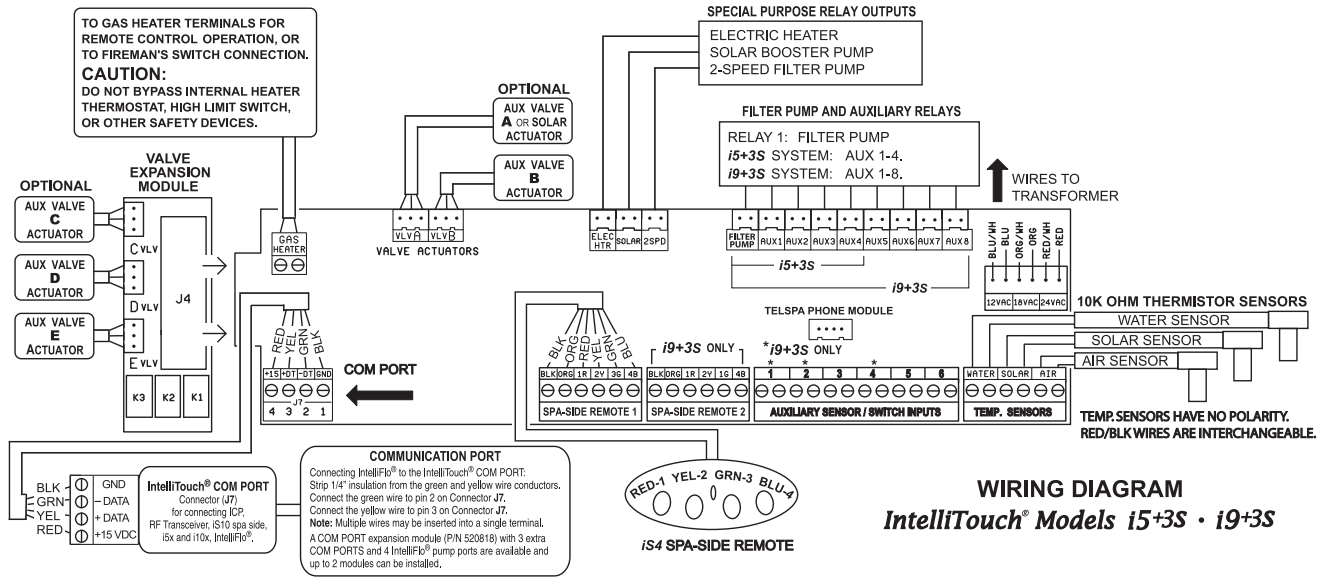
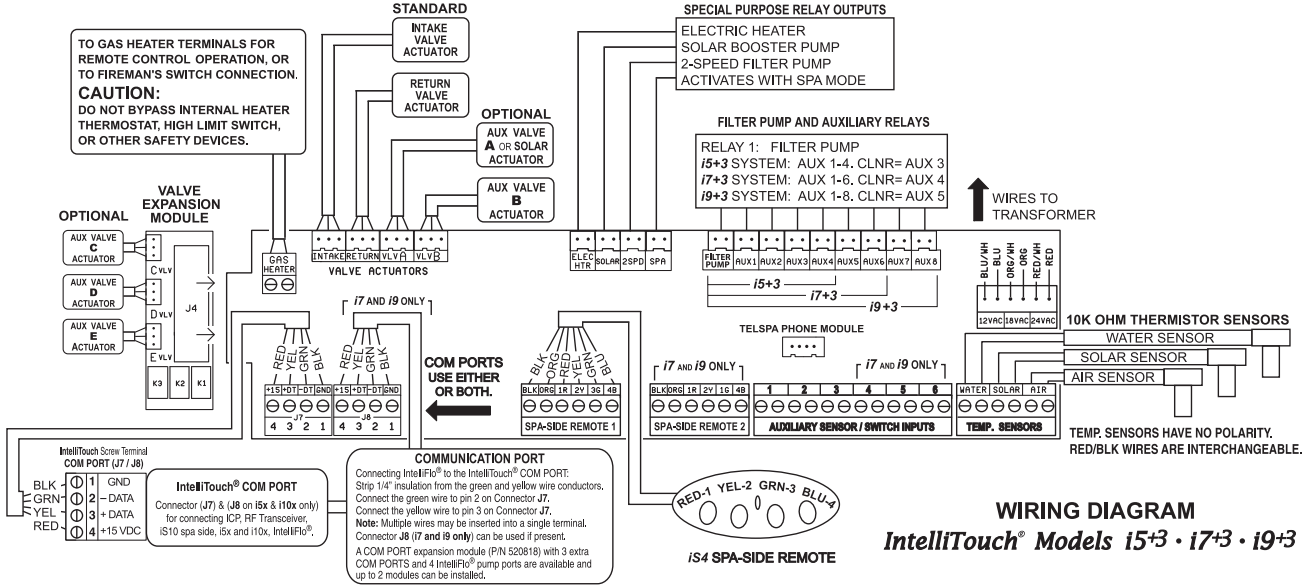

Wiring IntelliTouch to a Salt Chlorine Generator

Be sure to check the wire color and function of the salt chlorine generator before connecting it to the IntelliTouch COM port on the Personality board. See the wiring table below for the pin configuration.

Commonly used salt chlorine generator wiring is shown but you should still verify with the manufacturers documentation.

Failure to wire the salt chlorine generator properly can permanently damage the IntelliTouch system or chlorine generator.

Wiring Description

IntelliTouch COM port wiring color connection	Description	Salt Chlorine Generator commonly used wire colors
PIN 4 (RED)	+15 VDC	RED
PIN 3 (YELLOW)	+ DATA	BLACK
PIN 2 (GREEN)	- DATA	YELLOW
PIN 1 (BLACK)	GROUND	GREEN

Wiring UltraTemp to IntelliTouch

Be sure to check the UltraTemp terminal block wire colors and pinouts (located on the back of the Auto Set board) before connecting it to the IntelliTouch COM port on the Personality board. The See the wiring table below for the pin configuration.

IMPORTANT: On the UltraTemp AutoSet board ONLY CONNECT PIN 3 (YELLOW) and PIN 2 (GREEN) to the IntelliTouch COM port pins YELLOW and GREEN respectively. Do not connect pin 1 or pin 4 on the AutoSet board or the IntelliTouch Personality board. These pins are not used.

Wiring Description

IntelliTouch COM port wire color	Description	UltraTemp pin number and wire color
PIN 4 (RED) (DO NOT USE)	+15 VDC	PIN 4 (DO NOT USE)
PIN 3 (YELLOW)	+ DATA	PIN 3 (YELLOW)
PIN 2 (GREEN)	- DATA	PIN 2 (GREEN)
PIN 1 (BLACK)	GROUND	PIN 1

Glossary

Actuators: Motorized accessory for turning valves and diverting water; model CVA24T.

Color Set: Allows a combination of up to 12 SAm, SAL, IntelliBrite or Fiberworks lighting circuits to be preset to specific colors.

Color Swim: Allows a combination of up to 12 SAm, SAL, IntelliBrite or Fiberworks lighting circuits to be preset to transition through colors in sequence. This gives the appearance of colors dancing across your water.

Component ID: Unique identifier that tells the system what each component is.

Controller: Indoor Control Panel or MobileTouch wireless controller.

Expansion Kit: A kit that includes additional auxiliaries to an existing Personality Kit. Requires a Load Center or Power Center for each Expansion Kit.

Feature Circuits: Programmable circuits that may control relays, macros, and/or valve actuators.

Firmware: Factory installed operating system software dedicated for use with the IntelliTouch system; each type of control panel has its own firmware and release level.

Freeze Protection: Switches on a circuit if the air temperature drops below 35° F.

High Voltage Compartment: Large lower right compartment of Load Center or Power Center for all high voltage wiring including circuit breakers, relays, and GFCI.

House Address: Signal that allows Each IntelliTouch system the ability to group all its attached components under a single system identification; prevents the system from confusing its components from components on a neighbor's system.

ICP: Indoor Control Panel.

Indoor Control Panel: Fourteen button remote controller with LCD (liquid crystal display) is wired to the Personality board in the Power/Load Center.

iS4: Four function Spa-Side remote. Wall or deck mounted.

SpaCommand: Ten function spa-side remote with temperature changing capability and display. Wall or deck mounted.

Load Center: Metal enclosure with power relays, transformer, and circuit breakers. The Load Center is Installed prior to Personality Kit installation. Used for distributing power for controlling IntelliTouch Systems. Also known as the “sub-panel.”

Low Voltage Compartment: Top compartment of Load Center or Power Center for all low voltage wiring.

Low Voltage Raceway: Vertical space in the left side of Power/Load Center for low voltage cabling.

Macro: Feature circuit that allows you to combine circuits to activate together.

MobileTouch Controller: Wireless controller for the IntelliTouch Systems with all the functionality of the Indoor Control Panel.

Mud Box: Enclosure to provide mounting features for iS10 spa-side remote that is cast into gunite, concrete, or other spa wall/deck construction.

Outdoor Control Panel: Control panel with flexible hinge installed in upper portion of Load Center or Power Center to control IntelliTouch systems.

Glossary (Continued)

Personality Board: The circuit board mounted on top of the Outdoor Control Panel motherboard. The Personality board defines the system capabilities.

Personality Kit: Set of parts to define the capability of a system. Can include, temperature sensors, actuators, and additional relays, actuators.

Power Center: Same as Load Center with the exception of the circuit breaker base.

Relay Circuits: The circuits that control the relays on the Personality Board. Connectors on top edge of the circuit board.

Screw Terminal Connector: Removable connector that may attach to circuit board with multiple sockets (anywhere from 2 to 12) to receive wires from controllers and sensors; wires held by screw terminals; multiple wires of a small enough gauge (usually 22 AWG) may be coupled to a single socket of a terminal connector.

Transceiver: Circuit board with attached antenna that can send and receive radio frequency (wireless) transmissions.

Screw Terminal: Removable connector that may attach to circuit board with multiple sockets (anywhere from 2 to 12) to receive wires from controllers and sensors; wires held by screw terminals; multiple wires of a small enough gauge (usually 22 AWG) may be coupled to a single socket of a terminal connector.

System Personality: The capability of a system to operate a set of equipment, independent of the kind of controller or other accessories; system personalities include “shared equipment” (i5+3, i7+3, i9+3), “dual equipment” (i10+3D), or “single body of water” (i5S+3, i9+3S).

Temperature Sensor: Specially designed probe for measuring temperature of the air or pool water; 10k Ohm thermistor.

Terminal Connector: Removable connector that may attach to PCB with multiple sockets (anywhere from 2 to 12) to receive wires from controllers and sensors; wires held by screw terminals; multiple wires of a small enough gage (usually 22 AWG) may be coupled to a single socket of a terminal connector.

Two-Speed Pump Relay: Relay to toggle a two-speed pump from low-speed to high-speed operation; does not turn pump on or off.

Transceiver: Special printed circuit board that can send and receive radio frequency (wireless) transmissions.

QuickTouch QT4: Provides switching of up to four remote control circuits from a wireless Hand-held Remote.

Valve Module: Accessory PCB (P/N 520285) to increase auxiliary actuator outputs from two to five.

How to BACKWASH Your Filter

When your filter pressure gauge is reads 8 - 10 lbs above the clean, starting pressure (after backwashing), it is time to backwash your filter. This process involves turning a valve so that the water will flow through the filter backwards, flushing out the dirt. Sand filters can have either a push-pull valve (also known as a slide valve) or a multiport valve. The multiport valve has multi-ports on the valve, usually six positions:

Position 1: FILTER: This is the normal operating position, except when backwashing, rinsing or wasting.

Position 2: RINSE: Position the handle in this setting for 20 seconds after backwashing to rinse tank.

Position 2: RECIRCULATE: Use position if the filter's broken (to keep pool water circulating).

Position 2: BACKWASH: Use this setting to reverse the flow in the filter and send water out of the waste line. Make sure valves are open or hoses rolled out

Position 2: CLOSED: Position the handle in this setting to close off flow from the pool, usually to work on the equipment. Do not operate pump with valve in closed position

Position 2: WASTE/DRAIN: Another filter bypass setting, but this setting sends the water out of the waste pipe (hose), instead of returning it to the pool. This setting is used to lower pool water level or to vacuum to waste.

To BACKWASH a sand filter with a multiport valve

Note: *If you are using an IntelliFlo pump with IntelliTouch, first set IntelliTouch in "SERVICE" mode (press the "System Control" button and select "Service" on the IntelliTouch outdoor control panel.*

1. Shut off the power to the pump.
2. Press down on valve handle, rotate valve from FILTER to BACKWASH position.
3. Roll out any backwash hose or open any waste line valves.
4. Open air bleeder valve on filter.
5. Switch the pump ON.
6. Watch pressure gauge for backpressure and hose for kinks. Be prepared to shut off pump quickly.
7. After the hose fills up with water, run for two to three 2 - 3 minutes or until the water runs clear.
8. Switch the pump OFF and reposition multiport valve handle to the RINSE position.
9. Switch the pump ON and run on rinse for 15 - 25 seconds.
9. Switch the pump OFF and move multiport valve handle to the FILTER position.
10. Switch the pump ON and note lower pressure. Roll up the backwash hose.

To BACKWASH a sand filter with a slide valve

Note: *If you are using an IntelliFlo pump with IntelliTouch, first set IntelliTouch in "SERVICE" mode (press the "System Control" button and select "Service" on the IntelliTouch outdoor control panel.*

1. Switch the pump OFF, roll out backwash hose.
2. Twist to unlock plunger T-handle, pull / twist plunger upwards 2" to 3".
3. Open air bleeder assembly on filter, and switch the pump ON.
4. Watch pressure gauge for backpressure (+ 40 PSI) and hose for kinks. Be prepared to shut off pump quickly.
5. After the hose fills with water, run for 2 - 3 minutes or until water runs clear.
6. Switch the pump OFF and push T-handle back down into locked position.
7. Switch the pump ON and note lower pressure. Roll up the backwash hose.



P/N 521075 Rev. A